

# JBC

[www.jbctools.com](http://www.jbctools.com)

## INSTRUCTION MANUAL



## Complete Rework Station with Pneumatic Pump

Ref. RMVE-QE

# Packing List

The following items are included:

**JTSE Control Unit** .....1 unit  
 Ref. JTSE-1A (100V - 120V)  
 JTSE-2A (230V)



**DDE Control Unit** ..... 1 unit  
 Ref. DDE-1C (120V)  
 DDE-2C (230V)  
 DDE-9C (100V)



**Pneumatic Desoldering Module** ..... 1 unit  
 Ref. MVE-A



**Stand** ..... 1 unit  
 Ref. JT-SE



**Stand** ..... 1 unit  
 Ref. AD-SE



**Stand** ..... 1 unit  
 Ref. DR-SE



**Heater hose set** ..... 1 unit  
 Ref. JT-T1A (100V / 120V)  
 JT-T2A (230V)



**General Purpose Handle** ..... 1 unit  
 Ref. T245-A



**Desoldering Iron** ..... 1 unit  
 Ref. DR560-A  
*C560003 already inserted*



## JT Accessory set

Ref. 0012332

**Extractor stand** ..... 1 unit  
Ref. 0008752

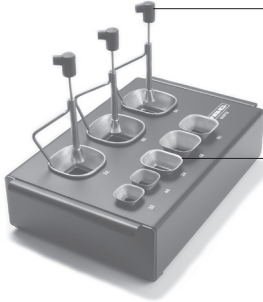

**Extractors**  
Ref. E2184  
E2064  
E2052

**Tripod**  
Ref. T2050  
(Ø 39mm)  
T2250  
(Ø 85mm)



**Protectors**  
Ref. P2220  
P2230  
P2235  
P4000  
P4010

**Suction Tube**  
Ref. 0932330



**ESD Tip Cleaner** ..... 1 unit  
Ref. CL8499



**Suction Cups**  
Ref. 0930110  
Ø 10 - 0934050 (x3)  
Ø 4.7 - 0934070 (x1)



**Nozzles**  
Ref. JN2015 (x1)  
JN2012 (x1)  
JN2020 (x1)



**Sponge** ..... 1 unit  
Ref. S0354



**Metal Brush** ..... 1 unit  
Ref. CL6217



**Sponge** ..... 1 unit  
Ref. CL6210



## DR560 Accessories

Ref. 0022819

**Tip cleaning set** ..... 1 unit  
Ref. 0965970



**Long Tip Cleaning set** ..... 1 unit  
Ref. 0965760

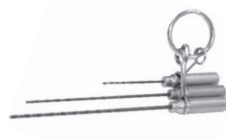

**Glass solder collector** ..... 1 unit  
Ref. 0812620



**Spanner** ..... 1 unit  
Ref. 0780550



**Filter Box** ..... 1 unit  
Ref. 0780840  
*It contains 10 filters*



**Internal gasket** ..... 1 unit  
Ref. 0019208  
*It contains 2 gaskets*



**Metal solder collector** ..... 1 unit  
Ref. 0812630



**Venturi Filter** ... 1 unit  
Ref. 0008446



**Cotton Filter** ... 1 unit  
Ref. 0781046  
*It contains 10 filters*



**Filter Box** ..... 1 unit  
Ref. 0005966  
*It contains 50 filters*



**Suction Filter** ... 1 unit  
Ref. 0821830



**Pick & Place** ..... 1 unit  
Ref. T260-A



**Bent Needles Set** ..... 1 unit  
Ref. 0861660



**Straight Needles Set** ... 1 unit  
Ref. 0901546



**Thermocouple**  
**Type K** ..... 1 unit  
Ref. PH218



**Cups Set** ..... 1 unit  
Ref. 0940163



**Cleaning stick** ..... 1 unit  
Ref. 0786640



**Power cord**  
For DDE ..... 1 unit  
Ref. 0013671 (100/120V)  
0010569 (230V)



**Module Cable** ..... 1 unit  
Ref. 0014874



**Stand Cable** ..... 2 units  
Ref. 0011283



**Kapton Tape** ..... 1 unit  
Ref. PH217



**Power cord**  
For JTSE ..... 1 unit  
Ref. 0009417 (100V/120V)  
0009401 (230V)



**Union**  
**Flanges** ..... 1 unit  
Ref. 0011356



**Cartridge**  
**holder** ..... 1 unit  
Ref. SCH-A



**Manual** ..... 1 unit  
Ref. 0023138

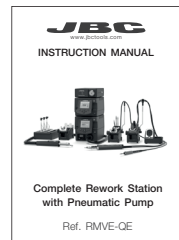

# Connections

Work simultaneously with **up to 2 tools** and join each station port with **1 module** + 1 pedal (Peripherals).

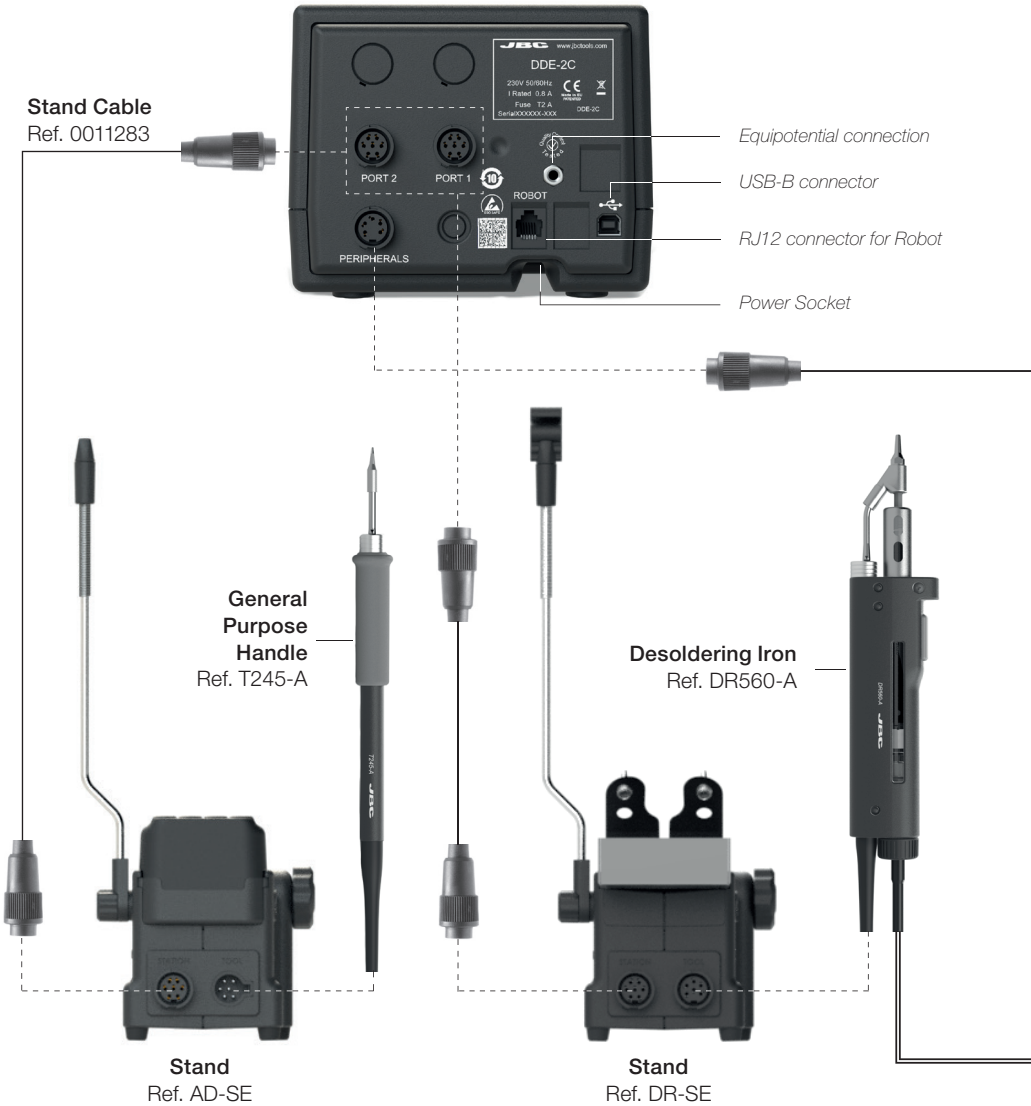

## JTSE Connection

**Stand**  
Ref. JT-SE



- Auxiliar connector
- Equipotential connector
- USB connector
- Robot RS232 connector
- Power Socket
- Fuse

*P-005 Pedal connector*

**Pneumatic Desoldering Module**  
Ref. MVE-A



*To another peripheral*

**To Pedal**  
Ref. P-005

*Air pressure (4-6 bar)  
Tubing Ø4xØ6 mm  
(Not supplied)*

**Suction Filter**  
Ref. 0821830



## DDE Features



## JTSE Features

### Thermocouple type K Ref. PH218



Activates the suction pump

Suction Tube  
For tripods and extractors



Heater Hose set  
Ref. JT-T1A (100V/120V)  
JT-T2A (230V)

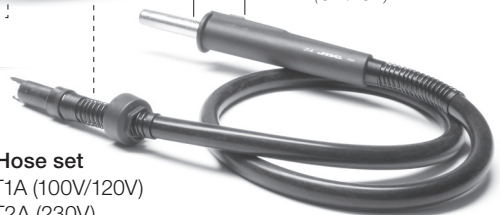



## DDE Work Screen

The DDE offers an intuitive user interface which provides quick access to station parameters.

**Default PIN: 0105**

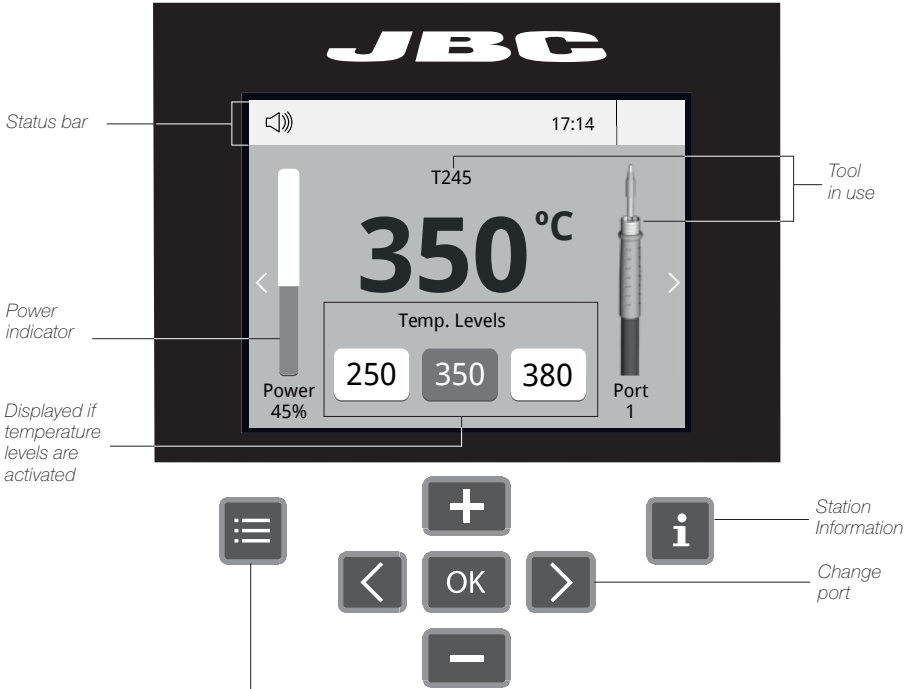

### Menu Options



Set the station parameters

#### Station

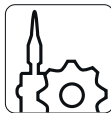

Set the tool parameters

#### Tools



Display the hours worked in each cycle

#### Counters

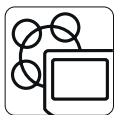

Consult / modify the links of the peripherals connected to the station with the port they are connected to.

#### Peripherals



It is possible to choose the language from a list.

#### Language



Allows you to carry out an overall station reset restoring all the parameters to their default values.

#### Reset

## Advanced functionalities



Graphics

It provides detailed graphics of tip temperature and power delivery in real time during solder joint formation for analysis purposes. This helps you decide how to adjust your process or which tip to use to obtain the best quality soldering.



Profiles

Designed to avoid thermal shock when soldering Ceramic Chip components like MLCC, this new and unique feature allows controlling the heating ramp up rate of the tool to gradually increase the temperature of the component through all the phases of the soldering process. Up to 25 fully configurable soldering profiles can be stored.

**JBC Net**

### The first system to optimize traceability in soldering

- Get greater quality and control in your production
- Manage your whole soldering process remotely in real time

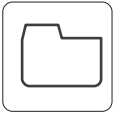

Files

### Export graphics

Insert a USB flash drive into the USB-A connector to save your soldering process in csv format.



Update

### Station update

Download the JBC Update File from [www.jbctools.com/software.html](http://www.jbctools.com/software.html)  
Insert the USB flash drive with the file downloaded to the station.



## System notifications

The following icons will be displayed on the screen's status bar.



USB flash drive is connected.



Station is controlled by a PC.



Station is controlled by a robot.



Station software update.  
Press INFO to start the process.



Warning.  
Press INFO for failure description.



Error.  
Press INFO for failure description,  
the type of error and how to proceed.

## MVE Initial Set up

1. After connecting the module, enter the Peripherals Menu and select the port which you want to join with the module.
2. Select the module from the list of peripheral connections. Remember your first connection is denoted as "a", the second being "b", etc. (e.g. MV\_a, MV\_b,...).
3. Press Menu or Back to save changes.

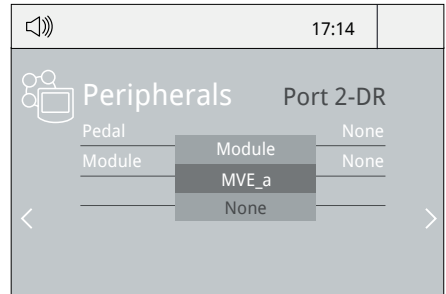

## Pedal Initial Set up\*

1. Enter the **Peripherals** Menu and **select the port** which you want to join to the pedal.

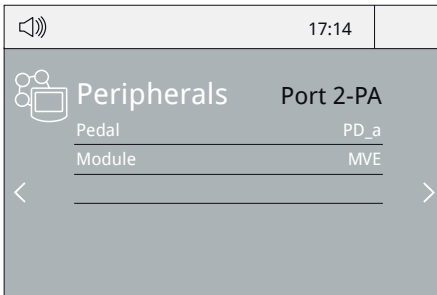

2. Select the pedal from the list (*Note that your first connection is denoted as "a", the second being "b", etc. (e.g. PD\_a, PD\_b,...).*)

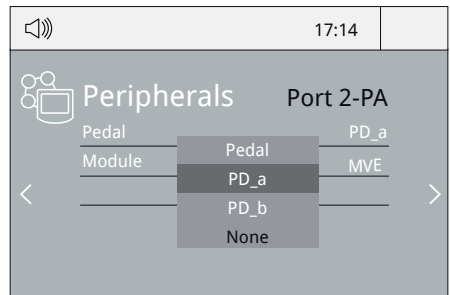

3. Set the pedal function according to your work needs:

Select how the pedal acts: as **Sleep**, **Extractor** (hibernation) or as a **module** switch.

Select the activating mode of the pedal (**pressed/released**)

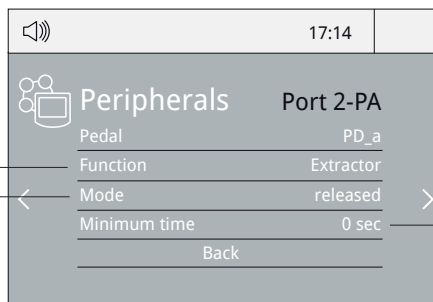

Set the duration of the activation time when pressing the pedal **once\*\***. For continuous functioning keep the pedal pressed.

\*Ref. P-005 (Not included)

\*\*NB: The same can be applied inversely when continually pressing the pedal and releasing to activate.

# Operation

## The JBC Most Efficient Soldering System

Our revolutionary technology is able to recover tip temperature extremely quickly. It means the user can work at a lower temperature and improve the quality of soldering. The tip temperature is further reduced thanks to the Sleep and Hibernation modes which increase up to 5 times the life of the tip.

### 1. Work

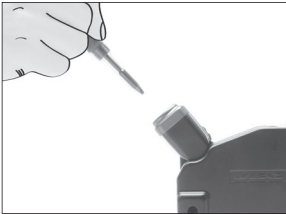

When the tool is lifted from the stand the tip will heat up to the selected temperature.

### 2. Sleep

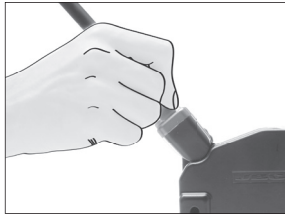

When the tool is in the stand, the temperature falls to the preset Sleep temperature.

### 3. Hibernation

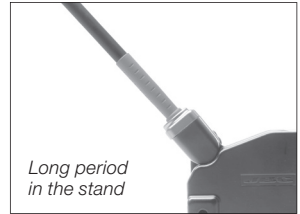

After longer periods of inactivity, the power is cut off and the tool cools down to room temperature.

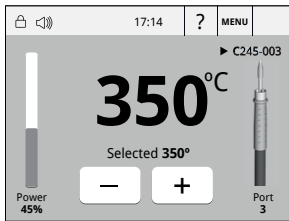

#### Tools Menu:

- Adjust temperature limits and cartridge.
- Set temperature levels.



#### Tools Menu:

- Set Sleep temperature.
- Set Sleep delay. (from 0 to 9 min or no Sleep)

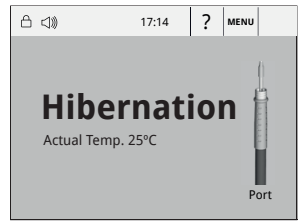

#### Tools Menu:

- Set Hibernation delay. (from 0 to 60 min or no hibernation)

## Desoldering process

Use a tip with a larger diameter than the pad to achieve maximum aspiration and thermal efficiency.

### 1. Placing

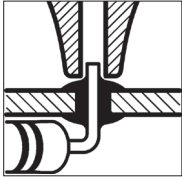

Place the tip over the lead.

### 2. Rotating

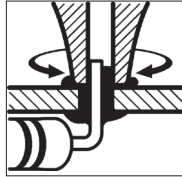

When the solder melts, gently move the tip in a circular motion.

### 3. Aspirating



Press and hold the tool button to start the suction and continue the movement completing 3 or 4 circles.

### 4. Removing

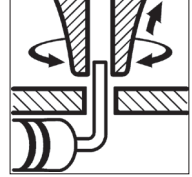

Remove the tip while maintaining the suction to make sure all the solder is removed from the joint.

If any solder remains are left on a terminal after desoldering it, resolder it with fresh solder and repeat the desoldering operation.

If desoldering tips does not provide enough heat to desolder leads from ground planes, consider using a preheater PCB.

## Quick Tip Changer

Save time and change cartridges safely without switching the station off. Be careful, the cartridges may be hot, when placing them in the storage rack.

### 1. Removing



Place the cartridge in the extractor and pull the handle to remove it.

### 2. Inserting



Place the handle on top of the new cartridge and press down.

### 3. Fixing

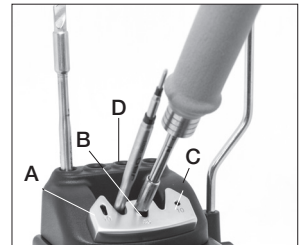

Use the holes to fix the cartridge as follows:

- A. For curved C210
- B. For C245
- C. For straight C210
- D. cartridge Storage rack

**Important:** It is essential to insert the cartridge as far as the mark for a proper connection.



# DR560 Changing Tips

## 1. Removing

Unscrew the tip using the spanner supplied.

## 2. Inserting

Fit the new tip and tighten with the spanner to make sure it is air tight.

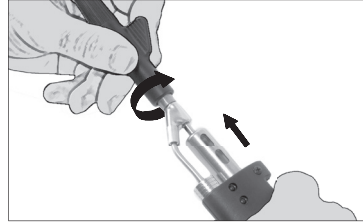

The DR560 uses C560 tips.

Find the model that best suits your soldering needs in [www.jbctools.com](http://www.jbctools.com)

# Glass Solder Collector Cleaning

## 1. Removing the lid

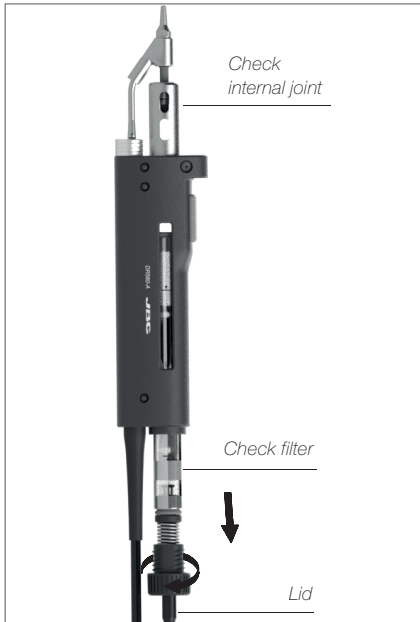

The lid must be unscrewed with the DR560 in a vertical position.

## 2. Cleaning



Remove the coil and clean the inside of the glass solder collector with the cleaning stick.

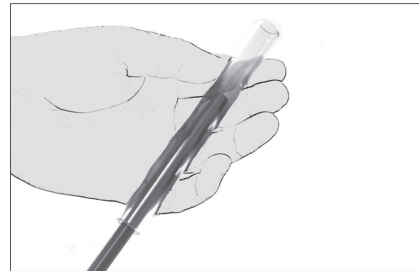

Check the filter and replace it if it is dirty or damaged.

## 3. Inserting the glass solder collector

The glass solder collector must be inserted with coil filter in place, positioned between the 2 lines marked. Then the whole unit must be closed by screwing the lid.



## DR560 Maintenance

### Tip Care

The intake tube should be periodically cleaned with the largest rod possible.

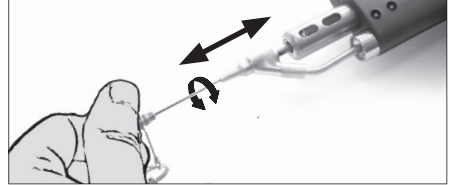
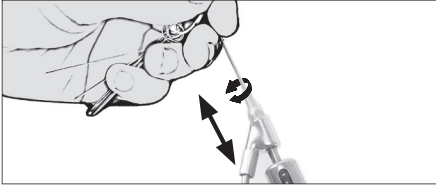

#### Important

DO NOT press the vacuum pump button while tinning the desoldering tip, as the fumes given off by the flux would quickly block the ducts and the air filter.

### MVE Changing filters

- Keep the casing clean by using a damp cloth. Periodically check all cable and tube connections.
- Keep filters clean to ensure proper solder suction and replace them when necessary.

#### Important

Do not use sharp pointed objects to open the suction filter.

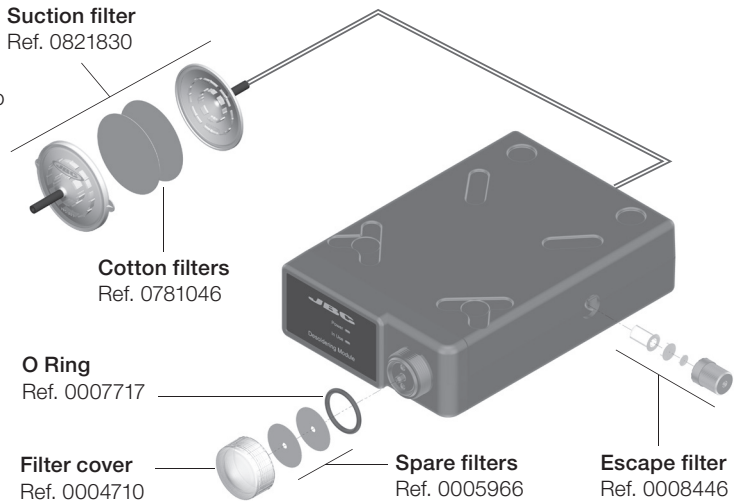

### Removing the pneumatic tubing

Push the release ring to remove the pneumatic tubing.

Release ring

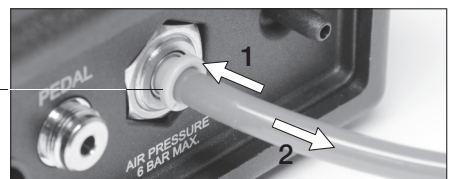

# Tip Cleaner

Improve thermal transfer by cleaning the tip after each solder joint.

## Brass wool

Ref. CL6210

*Very effective cleaning method. It leaves a small layer of solder on the tip to prevent oxidation between cleaning and reflowing.*

## Splashguard

Ref. 0017576

*It prevents splashing of solder particles when using the brass wool.*

## Antisplash Membrane

Ref. 0017574

*Prevents splashing to maintain the work area clean.*

## ESD Tip Wiper

Ref. CL0240

*A temperature resistant receptacle lets the operator remove excess solder by gentle tapping or wiping.*

## Sponge

Ref. S0354

*The least harmful cleaning method. Keep the sponge damp with distilled water when working to avoid tip wear.*

## Non-slip base

*No need to hold the base while cleaning tips.*

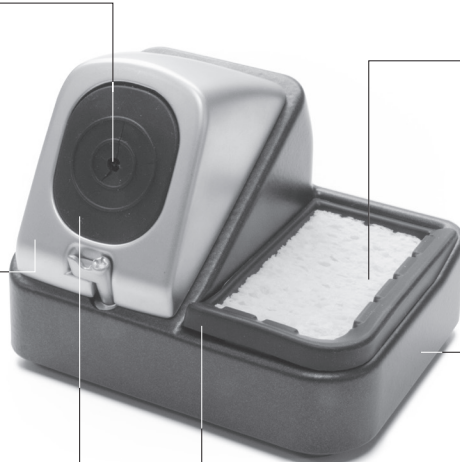

### Tapping:

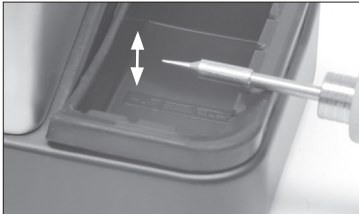

*Tap to remove excess solder.*

### Wiping:



*Use the slots to remove remaining particles.*



## JTSE / TESE Work Screen

The JTSE/TESE offers an **intuitive user interface** which provides **quick access** to station parameters.

**Default PIN: 0105**

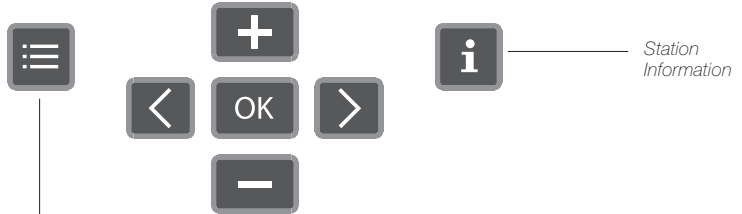
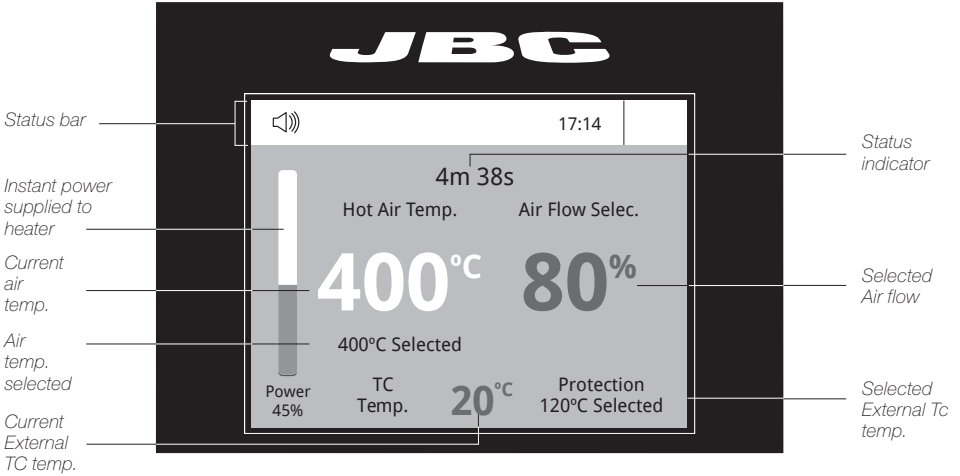

### Menu Options



Set the station parameters

**Station**



Set the tool parameters

**Tools**



Display the hours worked in each cycle

**Counters**



It is possible to choose the language from a list.

**Language**



Allows you to carry out an overall station reset restoring all the parameters to their default values.

**Reset**

# Advanced functionalities



## Profiles

To work with profiles it is essential to use the RWB / RWS / RWT rework arms. The Rework Arms supports the Hot Air Heater maintaining the distance and position to the component.

In this mode you can **set up or edit** as many as 25 profiles of temperature and air flow.

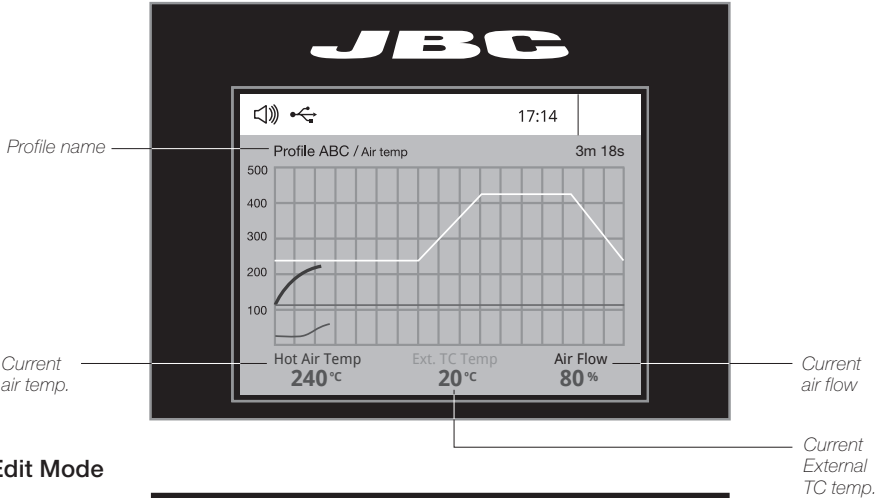

## Edit Mode

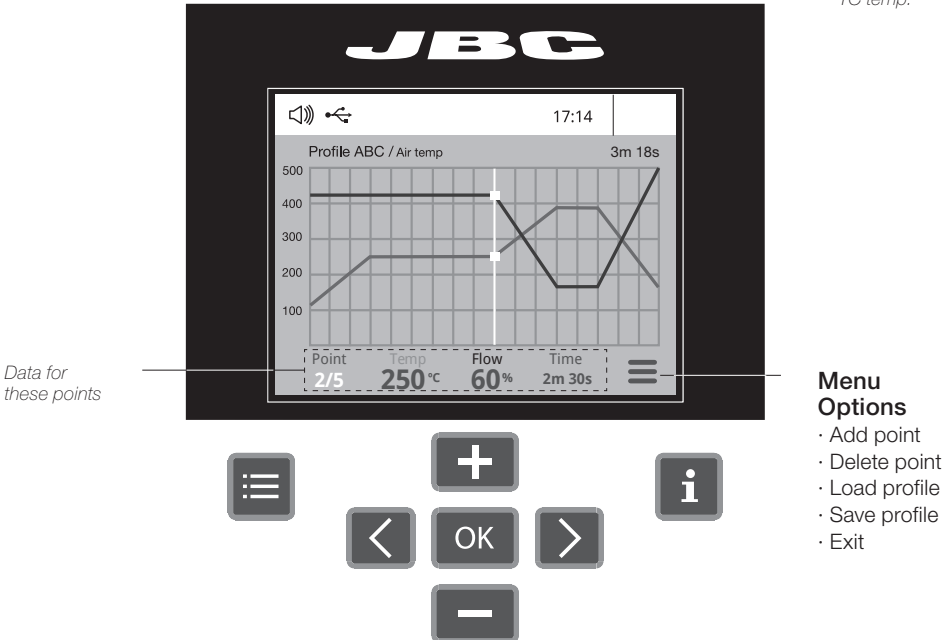



Graphics

By pressing **Graphics** in the main MENU, temperature and power figures in real time are displayed. This helps you decide which tip to use to obtain the best quality solder joints.



JBC Net

### The first system to optimize traceability in soldering

- Get greater quality and control in your production
- Manage your whole soldering process remotely in real time



Files

### Export graphics

Insert a USB flash drive into the USB-A connector to save your soldering process in csv format.



Update

### Station update

Download the JBC Update File from [www.jbctools.com/software.html](http://www.jbctools.com/software.html)  
Insert the USB flash drive with the file downloaded to the station.



## System notifications

The following icons will be displayed on the screen's status bar.



USB flash drive is connected.



Station software update.  
Press INFO to start the process.



Station is controlled by a PC.



Warning.  
Press INFO for failure description.



Station is controlled by a robot.



Error.  
Press INFO for failure description, the type of error and how to proceed.

# Adjustable Stand

Adjust the tool holder angle to suit your work position.

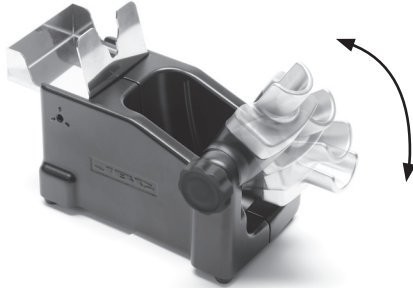

## Operation Modes

1. From the Tool Settings Menu, select the mode to activate the tool depending on the task.

### Tool button



Press the start/stop button to blow hot air.

### Pedal\*

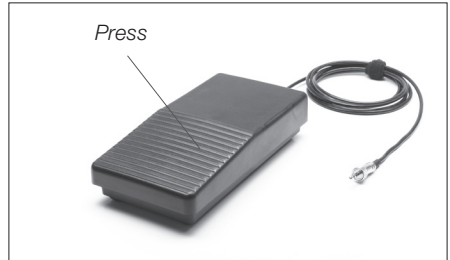

Press the Pedal to blow hot air and release to stop.

*\*The P-005 Pedal is not supplied with this station. See our website.*

2. The tool stops blowing when pressing the start/stop button.  
If the stand is connected to the station and for safety it will also stop when returned to the stand.

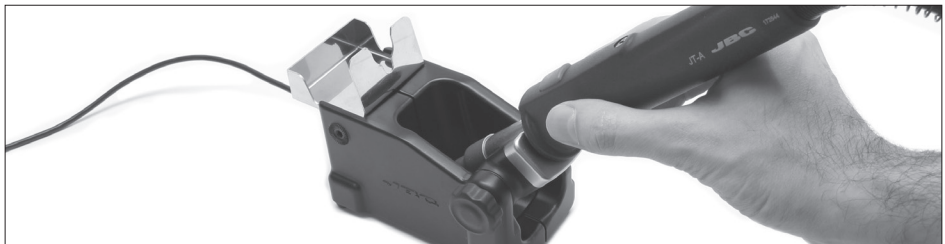

## Operation

### 1. Placing

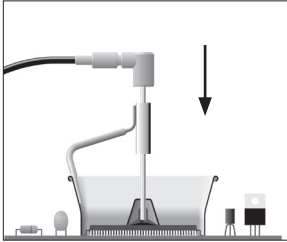

Position the extractor with the appropriate suction cup and press the suction button.

### 2. Heating



Heat the component.

### 3. Extracting

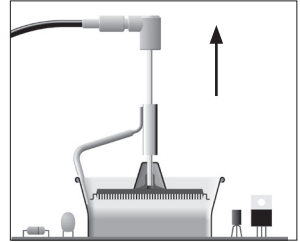

The component lifts off automatically when the solder melts.

## Protectors & Extractors

### For small components (fig. 1 and 2).

We recommend using the protector + tripod

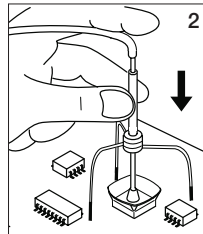
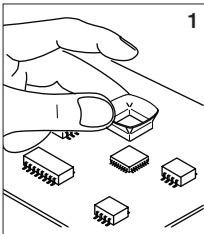

### For large components (fig. 3 and 4).

We recommend using the manual extractors

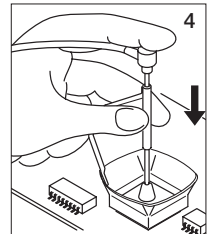
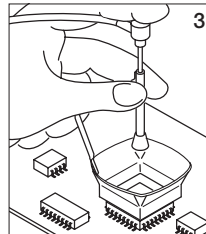

# Pick & Place *(not supplied with JT)*

This tool helps you place and remove SMDs of any size easily thanks to the suction pump.

**Pick & Place**  
Ref. T260-A



**Bent Needles Set**  
Ref. 0861660



**Straight Needles Set**  
Ref. 0901546





## Operation

Choose the needle and the suction cup that best fits the component and start as follows:

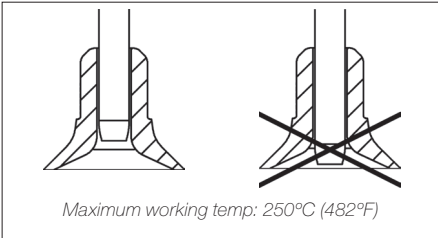

*Press the button to start/stop the suction*

*Suction cups*



*Maximum working temp: 250°C (482°F)*

Insert the needle with the appropriate cup for a correct suction process.

Make sure the needle does not protrude from the cup.

**1. Suction**

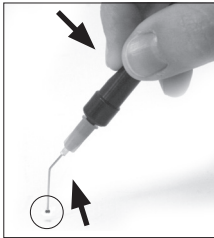

Once the suction is activated, cover the pen hole with your finger and lift off the component.

**2. Release**

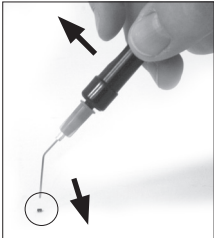

Lift your finger to release the component.

## Accessories

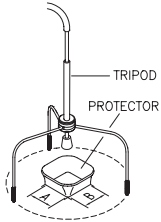

### Protectors

*	Ref.	AxB (mm)	AxB (in)	*	Ref.	AxB (mm)	AxB (in)
	<b>P3353</b>	4,3 x 3	0.16 x 0.12		<b>P1249</b>	12 x 23	0.47 x 0.9
	<b>P3786</b>	5,2 x 5,2	0.20 x 0.20	44	<b>P4000</b>	12,5 x 12,5	0.49 x 0.49
	<b>P3352</b>	5,2 x 7,5	0.20 x 0.29		<b>P3354</b>	13,2 x 13,2	0.52 x 0.52
	<b>P3355</b>	5,2 x 9,5	0.20 x 0.37		<b>P4025</b>	13,5 x 21,5	0.53 x 0.85
	<b>P3356</b>	6,2 x 4,2	0.24 x 0.16	48	<b>P2230</b>	15 x 15	0.59 x 0.59
	<b>P3785</b>	7,2 x 7,2	0.28 x 0.28	60	<b>P4010</b>	17 x 17	0.67 x 0.67
	<b>P3784</b>	8,2 x 8,2	0.32 x 0.32		<b>P4005</b>	18 x 29	0.71 x 1.14
	<b>P4035</b>	9 x 13	0.35 x 0.51		<b>P4030</b>	18,5 x 18,5	0.73 x 0.73
	<b>P4040</b>	9,5 x 19	0.7 x 0.74		<b>P1068</b>	18,5 x 24	0.73 x 0.94
	<b>P4080</b>	9,5 x 21	9.5 x 0.83		<b>P2685</b>	28,5 x 28,5	1.12 x 1.12
32	<b>P2220</b>	10 x 10	0.39 x 0.39		<b>P4085</b>	31,5 x 31,5	1.24 x 1.24
	<b>P4045</b>	10,5 x 21	0.14 x 0.82		<b>P2672</b>	33 x 46	1.30 x 1.18
	<b>P4090</b>	11 x 16	0.43 x 0.63		<b>P4002</b>	50 x 50	1.97 x 1.97
24	<b>P2235</b>	12 x 17	0.47 x 0.67		<b>P3357</b>	52,5 x 14	2.06 x 0.55

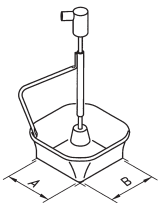

### Extractors

*	Ref.	AxB (mm)	AxB (in)	*	Ref.	AxB (mm)	AxB (in)
52	<b>E2052</b>	20 X 20	0.79 x 0.79		<b>E4015</b>	31,5 X 31,5	1.24 x 1.24
64	<b>E2064</b>	20 X 26	0.79 x 1.02		<b>E2084</b>	33 X 33	1.30 x 1.30
80	<b>E2184</b>	24 X 24	0.94 x 0.94		<b>E2100</b>	38 X 38	1.50 x 1.50
	<b>E2068</b>	27 X 27	1.06 x 1.06		<b>E2124</b>	45 X 45	1.77 x 1.77
	<b>E4020</b>	28,5 X 28,5	1.12 x 1.12				

### Tripods

Ref.	øC (mm)	øC (in)
<b>T2050</b>	39	1.53
<b>T2250</b>	85	3.35



### Manual extractor

Ref.	øD (mm)	øD (in)
<b>E2190</b>	7	0.27

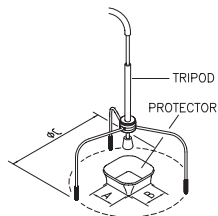

\* Reference Desk

# Using the Thermocouple type K

Connect a TC type K (PH218) to the station and use it as a protection or regulation sensor. You can define its use mode by means of the “Ext TC mode” option in the “Tool” menu.

You can choose from **two work modes**:

**Regulation:** the station regulates the air temperature automatically to maintain the External Thermocouple (TC) temperature.

**Protection:** the station cuts the air supply off when the External Thermocouple (TC) temperature is reached.

*Fix the TC with Kapton Tape (Ref. PH217) as near as possible to the component being worked on. If Kapton tape is not ESD you must use an ionizer.*

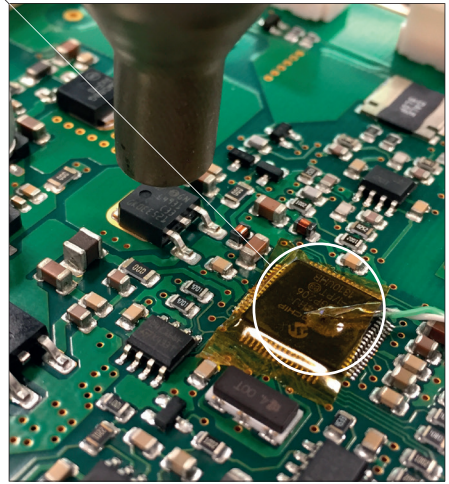
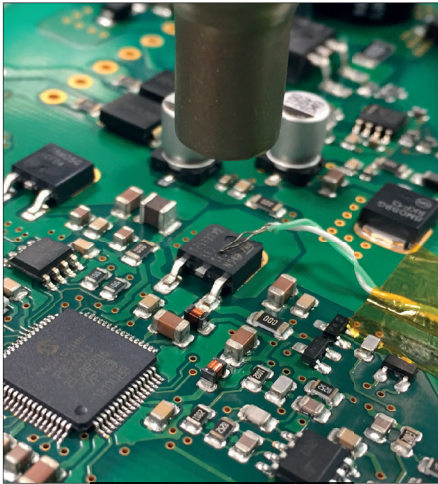

IPC\* does not recommend exceeding ramp-up rates over 3-4°C / sec. (5-7°F / sec) so as to reduce the risk of thermal stress on the PCB.

\* IPC was founded in the U.S. in 1957 as the Institute for Printed Circuits.

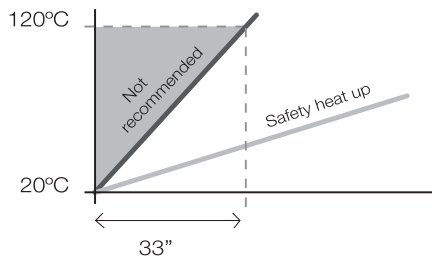



## Quick Nozzle Changer

Changing nozzles quickly and safely.

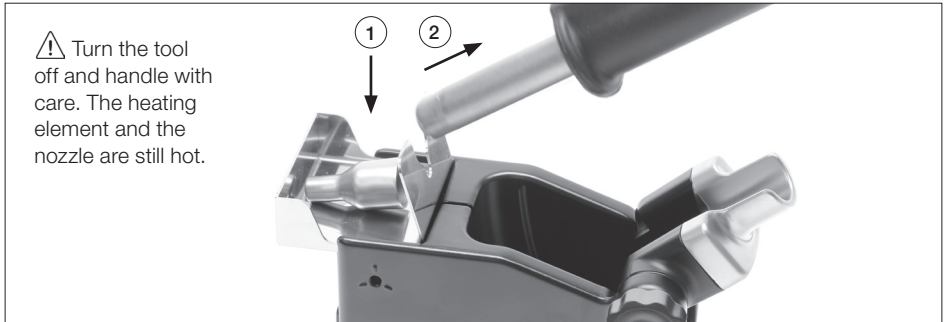

### Compatible Nozzles

The JT-TA works with JT nozzles. Find the model that best suits your soldering needs in [www.jbctools.com](http://www.jbctools.com)

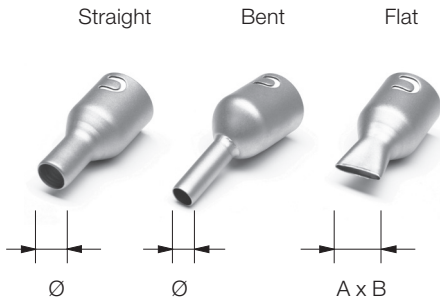

* Ref.	Shape	Ø Size (mm)	Ø Size (in)
JN2020	Straight	Ø 8	Ø 0.31
JN8417	Straight	Ø 10	Ø 0.4
* JN2015	Bent	Ø 4	Ø 0.16
* JN2012	Bent	Ø 6	Ø 0.24
JN6633	Bent	Ø 8	Ø 0.31
JN7637	Flat	10 x 2	0.4 x 0.08
JN7638	Flat	20 x 2	0.8 x 0.08
JN7639	Flat	30 x 2	1.18 x 0.08

\* Included in JT Accessory set (Ref. 0012332)

In case of a loosely fitting nozzle:

1. Push the nozzle tab inwards with a screwdriver or flat-nosed pliers.

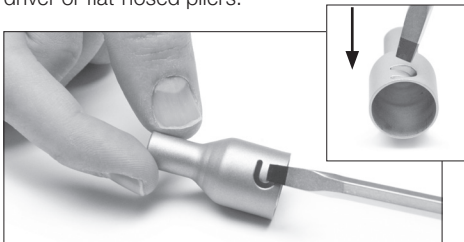

2. Insert the nozzle into the JT-TA again.

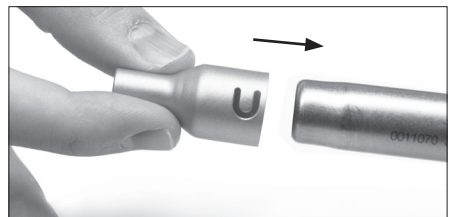

## Replacing the Heating Element

Only perform this operation when the element is cold and the unit is disconnected from the mains.

1. Loosen the screw.
2. Pull the heating element out of the handle.
3. Connect the new heating element, ensuring it is pushed all the way in.
4. Tighten the screw.

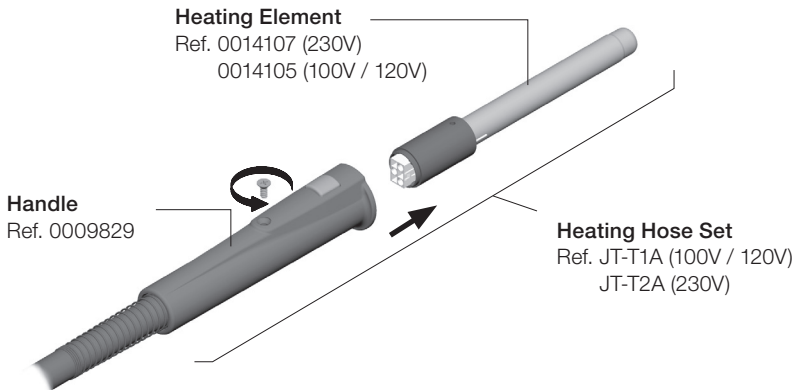

## Changing the JT-TA Heater Hose Set

1. Unplug the power cable.
2. Use a spanner to unscrew the nut.
3. Make sure that the new heater tube fits into the grooves in the socket.
4. Tighten the screw.

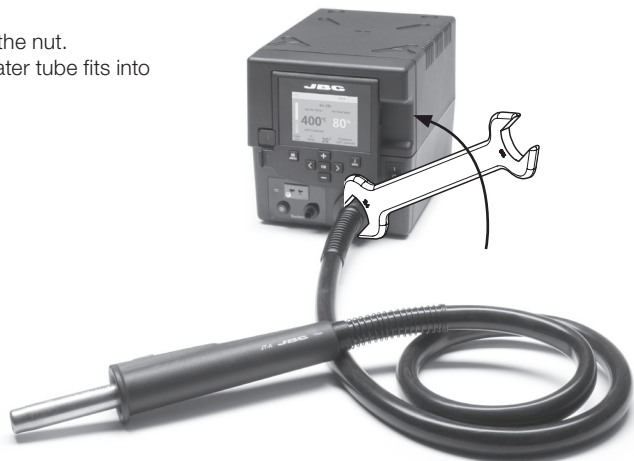

## DDE Compatibility

Select the equipment that best suit your soldering or desoldering needs.

Basic working system				Peripherals			
Control Unit	Stand	Tool	Cartridge Range	MSE-A / MVE-A	MNE-A	FSE-A	P-005**
DDE-C	AD-SE	T210-A	C210			●	●
		T245-A	C245			●	●
	DN-SE	T210-NA*	C210		●		●
		T245-NA*	C245				
	AP-SE	AP250-A	C250				●
	PA-SE	PA120-A	C120				●
	HT-SE	HT420-A	C420			●	●
	DS-SE	DS360-A	C360	●		●	●
DR-SE	DR560-A	C560	●		●	●	

\* MNE Nitrogen Flow Regulator required.

\*\* MSE / MVE Desoldering module required.

## MVE-A Compatibility

Module	Stand	Tool	Cartridge Range	Control Units		Peripherals
				DDE	DME	P-005
MVE-A	DS-SE	DS360-A	C360	●	●	●
	DR-SE	DR560-A	C560	●	●	●

## Hot Air Stations Compatibility

Basic working system				Nozzle		Peripherals
Control Unit	Tool	Heating Element	Stand	JN Series	TN Series	P-005
JTSE-A	JT-A	0014107 (230V)	JT-SE	●		●
		0014105 (100V/120V)				
TESE-B	TE-B	0012374 (100V/120V/230V)	TE-SE		●	●

# Maintenance

Before carrying out maintenance or storage, always allow the equipment to cool.

- Clean the station screen with a glass cleaner or a damp cloth.
- Use a damp cloth to clean the casing and the tool. Alcohol can only be used to clean the metal parts.
- Periodically check that the metal parts of the tool and stand are clean so that the station can detect the tool status.
- Maintain tip surface clean and tinned prior to storage in order to avoid tip oxidation. Rusty and dirty surfaces reduce heat transfer to the solder joint.
- Periodically check all cables and tubes.
- Replace a blown fuse as follows:

*Clean periodically*

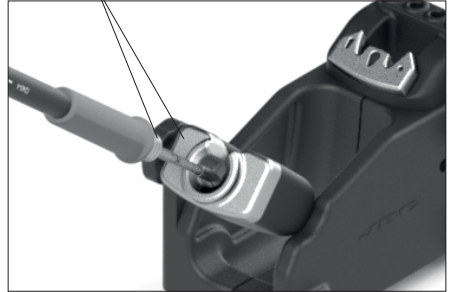

**1.** Pull off the fuse holder and remove the fuse. If necessary use a tool to lever it off.

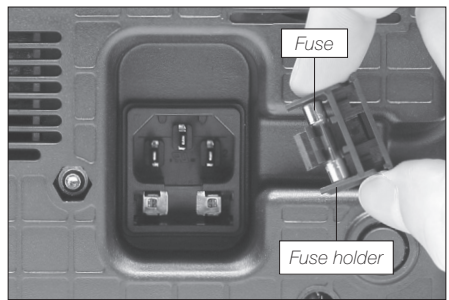

**2.** Press the new fuse into the fuse holder and replace it in the station.

- Replace any defective or damaged pieces. Use original JBC spare parts only.
- Repairs should only be performed by a JBC authorized technical service.

## Safety



**It is imperative to follow safety guidelines to prevent electric shock, injury, fire or explosion.**

- Do not use the units for any purpose other than soldering or rework. Incorrect use may cause fire.
- The power cord must be plugged into approved bases. Be sure that it is properly grounded before use. When unplugging it, hold the plug, not the wire.
- Do not work on electrically live parts.
- The tool should be placed in the stand when not in use in order to activate the sleep mode. The soldering tip, the metal part of the tool and the stand may still be hot even when the station is turned off. Handle with care, including when adjusting the stand position.
- Do not leave the appliance unattended when it is on.
- Do not cover the ventilation grills. Heat can cause inflammable products to ignite.
- Avoid the contact of flux with skin or eyes to prevent irritation.
- Be careful with the fumes produced when soldering.
- Keep your workplace clean and tidy. Wear appropriate protection glasses and gloves when working to avoid personal harm.
- Utmost care must be taken with liquid tin waste which can cause burns.
- This appliance can be used by children over the age of eight and also persons with reduced physical, sensory or mental capabilities or lack of experience provided that they have been given adequate supervision or instruction concerning use of the appliance and understand the hazards involved. Children must not play with the appliance.
- Maintenance must not be carried out by children unless supervised.

# 有害物质含量表

产品中有害物质的名称及含量

部件名称	有害物质					
	铅(Pb)	汞(Hg)	镉(Cd)	六价铬(Cr(VI))	多溴联苯(PBB)	多溴二苯醚(PBDE)
烙铁头	○	○	○	○	○	○
手柄	○	○	○	○	○	○
电源线	○	○	○	○	○	○
主机	○	○	○	○	○	○
电源插座	○	○	○	○	○	○
保险丝	○	○	○	○	○	○
主开关	○	○	○	○	○	○
电位连接	X	○	○	○	○	○
变压器	○	○	○	○	○	○
线路板	X	○	○	○	○	○

○ 表示该有害物质在该部件所有均质材料中的含量均在GB/T 26572 规定的限量要求以下。  
 X 表示该有害物质至少在该部件的某一均质材料中的含量超出GB/T 26572 规定的限量要求。

## Specifications

### Complete Rework station with Pneumatic Pump RMVE-1QE / RMVE-2QE / RMVE-9QE

**JTSE-1A** 100V - 120V 50/60Hz. Input fuse: 8A. Rated current: 7A

**JTSE-2A** 230V 50/60Hz. Input fuse: 4A. Rated current: 3A

- Nominal power: 700W
- Temperature selection: Room temp. / 150 - 450 °C (300 - 840 °F)
- Cool mode: T off. Used to blow air to room temperature
- Ambient operating temp.: 10 - 50 °C (50 - 122 °F)
- Air flow regulation: 5 - 50 SLPM
- Vacuum: 30% / 228 mmHg / 9 inHg
- Connectors: USB-A / USB-B  
RJ12 for RS232 (Robot)  
Pedal for P-005
- Control Unit Weight: 1,9 kg (4.2 lb)
- Control Unit Dimensions: 148 x 184 x 140 mm (5.83 x 7.24 x 5.51 in)

**DDE-1A** 120V 50/60Hz. Input fuse: 4A. Output: 23.5V

**DDE-2A** 230V 50/60Hz. Input fuse: 2A. Output: 23.5V

**DDE-9A** 100V 50/60Hz. Input fuse: 5A. Output: 23.5V

- Temperature Range: 90 - 450 °C (190 - 840 °F)
- Idle Temp. Stability (still air): ±1.5 °C (±3 °F)
- Output Peak Power: 150W per tool
- Tip to ground resistance: <2 ohms
- Tip to ground voltage: <2mV RMS
- Ambient Operating Temperature: 10 - 50 °C (50 - 122 °F)
- Connectors: USB-A / USB-B / Peripherals connectors  
RJ12 for RS-232 (Robot)
- Control Unit Weight: 3,815 kg (8.41 lb)
- Control Unit Dimensions: 148 x 120 x 232 mm (5.83 x 4.72 x 9.13 in)

#### MVE-A

- Ambient Operating Temperature: 10 - 50 °C (50 - 122 °F)
- Vacuum at 6 Bar: 90% / 680 mmHg / 26.8 inHg
- Flow rate: 15 SLPM
- Peripheral Weight: 0,7 kg (1.54 lb)
- Peripheral Dimensions: 145 x 55 x 225 mm (5.71 x 2.17 x 8.86 in)
- Connectors: Pedal for P-005
- Total Package: 480 x 340 x 380 mm / 15.90 kg  
18.9 x 14.6 x 15.0 in / 35.05 lb

Complies with CE standards.  
ESD protected.

# JBC

---

## Warranty

JBC's 2 year warranty covers this equipment against all manufacturing defects, including the replacement of defective parts and labour.

Warranty does not cover product wear or misuse.

In order for the warranty to be valid, equipment must be returned, postage paid, to the dealer where it was purchased.

**Get 1 extra year JBC warranty by registering here:**  
<https://www.jbctools.com/productregistration/>  
**within 30 days of purchase.**

---



This product should not be thrown in the garbage.

In accordance with the European directive 2012/19/EU, electronic equipment at the end of its life must be collected and returned to an authorized recycling facility.



[www.jbctools.com](http://www.jbctools.com)