

JBC

www.jbctools.com

| | Page |
|---------|------|
| English | 2 |
| Español | 9 |
| Deutsch | 17 |
| 中文 | 25 |

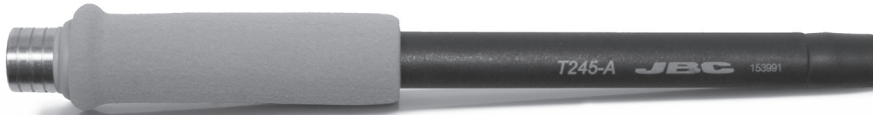

Soldering Iron Handles

Ref. T210 / T245 / T470

Features

For C245 Cartridge range

The soldering iron handles for general purposes are suitable for both SMD components and jobs with high power requirements (e.g. ground plane soldering).

General Purpose Handle

Ref. T245-A



Blue Handle

Ref. T245-PA



Non-slip Handle

Ref. T245-B



Soft Thermal Insulator Handle

Ref. T245-C



Easily replace the **Grips** using the slide-on tabs (Ref. 0016057 and Ref. 0018658).

1. Inserting tabs

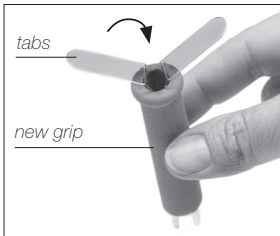

Insert the slide-on tabs into the new grip.

2. Inserting handle

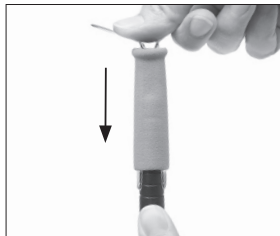

Push the grip with the tabs onto the handle.

3. Removing tabs

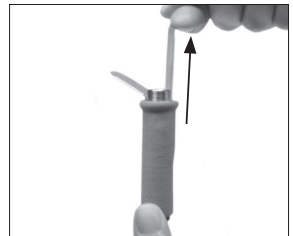

To remove the tabs, hold the grip and pull them out. Use a pliers if necessary.

Note: All models are supplied with a 1.5 m cable.

For C210 Cartridge range

The T210 handles are suitable for precision soldering jobs with medium power requirements. Due to their size, they work with conventional and small SMDs as well as under a microscope.

Precision Purpose Handle

Ref. T210-A



Blue Precision Handle

Ref. T210-PA

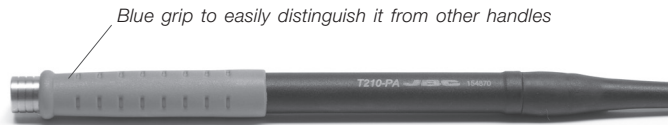

For C470 & C245 Cartridge ranges

For intensive soldering jobs requiring continued high thermal power. They feature good thermal insulation with a screw to fasten the cartridge which prevents rotation.

HD Purpose Handle

Ref. T470-A



Heavy Duty HD Handle

Ref. T470-B

HD Purpose Handle + 3m cable

Ref. T470-SA

Tri-lobed HD Handle

Ref. T470-ZA



Thermal Insulator HD Handle

Ref. T470-FA

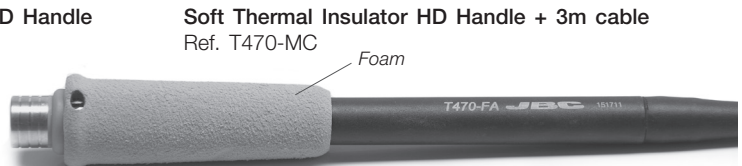

Soft Thermal Insulator HD Handle + 3m cable

Ref. T470-MC

Note: All models are supplied with a 1.5 m cable except those specified with 3 m.

Nitrogen Handles features

These are for working in an oxygen-free atmosphere providing better quality soldering. They offer extra heat to the solder joint and help prevent oxidation. The JBC GN-A Nitrogen Generator Module or an external nitrogen feed is needed at the operator's bench.

For C210 Cartridge range Nitrogen Precision Handle

Ref. T210-NA



Nozzles

Ref. B6647



For C245 Cartridge range Nitrogen Handle

Ref. T245-NA



Nozzles

Ref. B7243

B7244



For C470 Cartridge range Nitrogen HD Handle

Ref. T470-NA



Nozzles

Ref. B6193

B6194

B6195



Changing cartridges

Before changing the cartridge

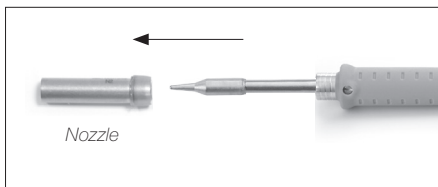

First remove the nozzle. Then loosen the screw to remove the cartridge (T245-NA / T470-NA).

Use a pliers to change or remove nozzles when hot.

After changing the cartridge

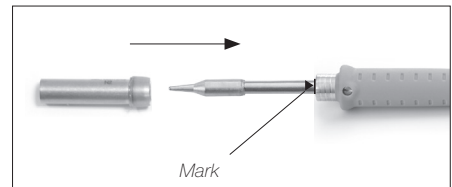

Insert the cartridge, tighten the screw and then place the nozzle.

T210 & T245 Changing cartridges

Save time and change cartridges safely without switching the station off.

1. Removing

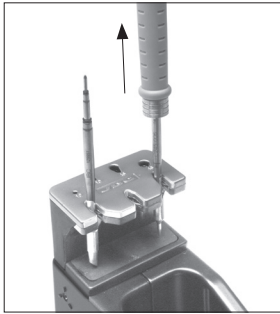

Place the handle in the extractor and pull to remove the cartridge.

2. Inserting

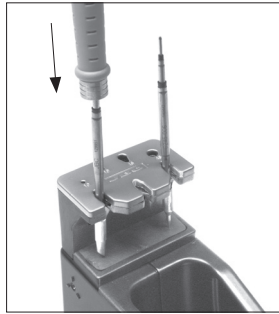

Place the handle on top of the new cartridge and press down.

3. Adjusting

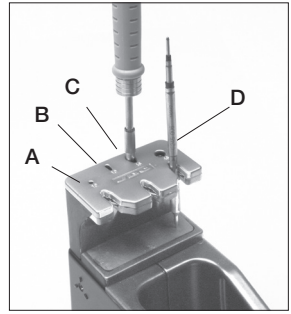

Use the holes for fixing the cartridge* as follows:
A. For straight C210.
B. For curved C210.
C. For curved C245.
D. For straight C245.

*Important

It is essential to insert the cartridges as far as the mark for a proper connection.

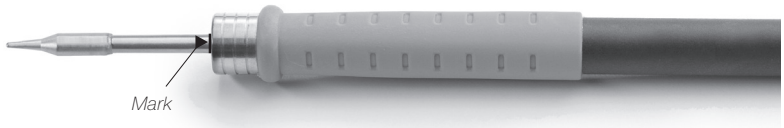

T470 Changing cartridges

1. Removing

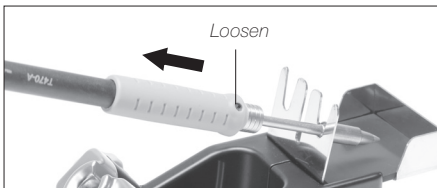

Loosen the screw. Place the Soldering Iron in the extractor and remove the cartridge.

2. Inserting



Insert the new cartridge* and press slightly as far as the mark and tighten the screw.

Compatibility

| Handle | Cartridge Range | CD | Stand | DI | DDE | DME | HDE |
|----------|-----------------|----|-------|----|-----|-----|-----|
| T210-A | C210 | ● | AD-SD | ● | ● | ● | |
| T210-PA | | ● | | ● | ● | ● | |
| T245-A | C245 | ● | | ● | ● | ● | |
| T245-PA | | ● | | ● | ● | ● | |
| T245-B | | ● | | ● | ● | ● | |
| T245-C | | ● | | ● | ● | ● | |
| T470-A | C245 | ● | AD-SD | ● | ● | ● | |
| | C470 | | HD-SD | | | | ● |
| T470-B | C245 | ● | AD-SD | ● | ● | ● | |
| | C470 | | HD-SD | | | | ● |
| T470-SA | C245 | ● | AD-SD | ● | ● | ● | |
| | C470 | | HD-SD | | | | ● |
| T470-ZA | C245 | ● | AD-SD | ● | ● | ● | |
| | C470 | | HD-SD | | | | ● |
| T470-FA | C245 | ● | AD-SD | ● | ● | ● | |
| | C470 | | HD-SD | | | | ● |
| T470-MC | C245 | ● | AD-SD | ● | ● | ● | |
| | C470 | | HD-SD | | | | ● |
| T210-NA* | C210 | | DN-SE | ● | ● | ● | |
| T245-NA* | C245 | | | ● | ● | ● | |
| T470-NA* | C245 | | | ● | ● | ● | |
| | C470 | | | | | | |

* The MNE Nitrogen Flow Regulator is required. Use the proper nozzle according to the cartridge.

Accessories

Fume extractor

Ref. F3435 (for T245 / T470)
 Ref. F3450 (for T210)

Clips can be easily removed for quick maintenance.



Cable collector

Ref. CC3702
 Keeps the work area free of cable.

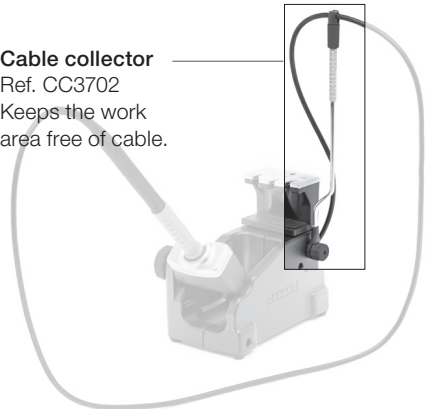

Safety



It is imperative to follow safety guidelines to prevent electric shock, injury, fire or explosion.

- Do not use the handle for any purpose other than soldering. Incorrect use may cause fire.
- When unplugging it, hold the plug, not the wire.
- Do not work on electrically live parts.
- The tool should be placed in the stand when not in use in order to activate the sleep mode. The soldering tip, the metal part of the tool and the stand may still be hot after the station is turned off. Handle with care, including when adjusting the stand position.
- Do not leave the appliance unattended when it is on.
- Avoid flux coming into contact with skin or eyes to prevent irritation
- Be careful with the fumes produced when soldering.
- Keep your workplace clean and tidy. Wear appropriate protection glasses and gloves when working to avoid personal harm.
- Utmost care must be taken with liquid tin waste which can cause burns.
- This appliance can be used by children over the age of eight as well as persons with reduced physical, sensory or mental capabilities or lacking experience provided that they have been given adequate supervision or instruction concerning use of the appliance and understand the hazards involved. Children must not play with the appliance.
- Maintenance must not be carried out by children unless supervised.

Maintenance

- Before carrying out maintenance, always unplug the stand and the tool.
- Check periodically that the metal parts of the tool and the stand are clean to ensure detection of the tool when it is in the stand. Use a damp cloth or alcohol.
- Periodically check all cables and tubes connections.
- Replace any defective or damaged pieces. Use original JBC spare parts only. Repairs should only be performed by a JBC authorized technical service.

Mangos Soldadores

Ref. T210 / T245 / T470

Características

Para gama de cartuchos C245

Los lápices soldadores para aplicaciones generales son idóneos tanto para componentes SMD como para trabajos con gran demanda de potencia (P. ej. Soldaduras conectadas a planos de masa).

General Purpose Handle · Mango para aplicaciones generales

Ref. T245-A



Blue Handle · Mango azul

Ref. T245-PA



Non-slip Handle · Mango antideslizante

Ref. T245-B



Soft Thermal Insulator Handle · Mango suave con aislamiento térmico

Ref. T245-C



Cambie fácilmente la **empuñadura de los mangos** usando los aplicadores (Ref. 0016057 y Ref. 0018658).

1. Inserte los aplicadores

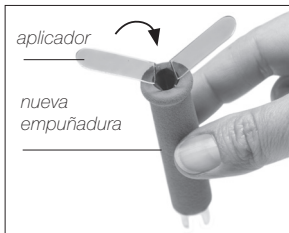

Introduzca los aplicadores en la nueva empuñadura.

2. Inserte el mango

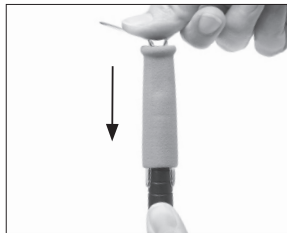

Inserte el conjunto en el mango y empuje hasta que quede bien situado.

3. Quite los aplicadores

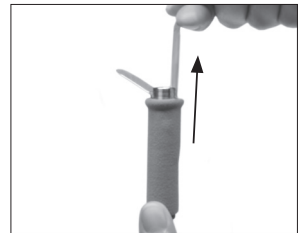

Para extraer los aplicadores agarre la empuñadura y tire hacia arriba.

Nota: Todos los modelos se suministran con un cable de 1,5 m.

Para gama de cartuchos C210

Los lápices soldadores para aplicaciones de precisión son idóneos para trabajos con demanda de potencia media. Debido a su tamaño, permiten la soldadura de pequeños componentes SMD, así como realizarla a través de un microscopio.

Precision Purpose Handle · Mango para aplicaciones de precisión

Ref. T210-A

**Blue Precision Handle · Mango de precisión azul**

Ref. T210-PA

**Para gamas de cartuchos C470 y C245**

Este tipo de lápices son los más idóneos para trabajos donde la soldadura requiere una continuada y alta potencia térmica. Presentan una empuñadura anti-deslizante e incorporan un tornillo para fijar el cartucho que evita su rotación y movimiento.

HD Purpose Handle*Mango HD*

Ref. T470-A

**Heavy Duty HD Handle***Mango HD de uso intensivo*

Ref. T470-B

HD Purpose Handle + 3m cable*Mango HD con cable de 3m*

Ref. T470-SA

Tri-lobed HD Handle · Mango HD trilobular

Ref. T470-ZA

**Thermal Insulator HD Handle***Mango HD con aislamiento térmico*

Ref. T470-FA



Soft Thermal Insulator HD Handle + 3m cable
Mango suave HD con aislamiento térmico con cable de 3m
Ref. T470-MC

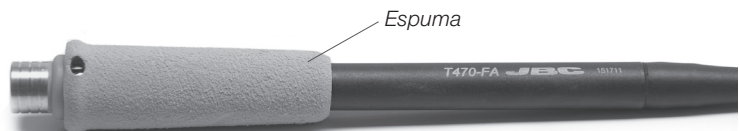

Nota: Todos los modelos se suministran con un cable de 1,5 m excepto aquellos indicados con 3 m.

Características de los mangos con aporte de nitrógeno

Este tipo de lápices permite crear una atmosfera libre de oxígeno alrededor de la soldadura que se esté realizando, dando lugar así a un trabajo de mayor calidad, ofreciendo un extra de temperatura y previniendo la oxidación. Para ello, es necesario disponer del Módulo Generador de Nitrógeno GN-A de JBC u otra alimentación externa.

Para gama de cartuchos C210

Nitrogen Precision Handle · Mango de precisión con aporte de nitrógeno
Ref. T210-NA



Para gama de cartuchos C245 Nitrogen Handle

Mango con aporte de nitrógeno
Ref. T245-NA



Boquillas
Ref. B6647

Para gama de cartuchos C470 Nitrogen HD Handle

Mango HD con aporte de nitrógeno
Ref. T470-NA



Boquillas
Ref. B6193
B6194
B6195

Cambio de cartuchos

Antes de cambiar el cartucho

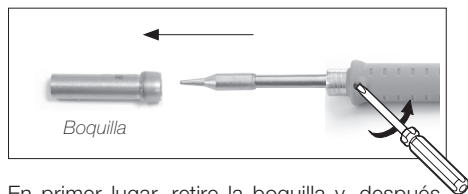

En primer lugar, retire la boquilla y, después, afloje el tornillo para quitar el cartucho (T245-NA / T470-NA). ⚠ Utilice unos alicates para cambiar o retirar las boquillas cuando estén a alta temperatura.

Después de cambiar el cartucho

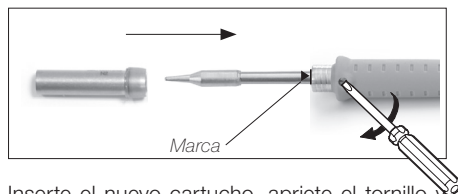

Inserte el nuevo cartucho, apriete el tornillo y después coloque la boquilla.

Cambio de cartuchos de los mangos T210 y T245

Ahorre tiempo y cambie cartuchos con seguridad sin desconectar la estación.

1. Retire

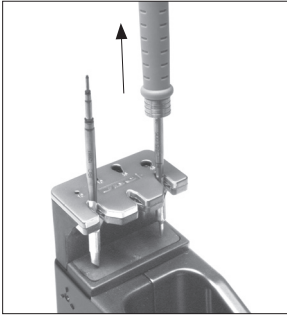

Coloque el lápiz soldador en las ranuras del extractor y tire hacia arriba para retirar el cartucho.

2. Inserte

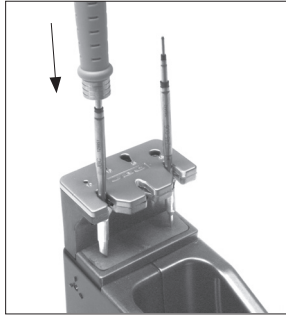

Coloque el lápiz soldador en la parte superior del nuevo cartucho y empuje hacia abajo ligeramente.

3. Ajuste

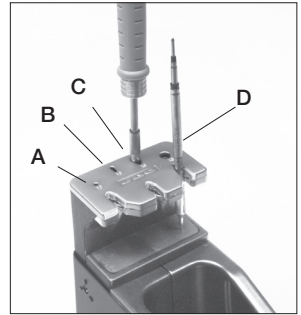

Utilice los agujeros fijadores para ajustar el cartucho*:

A. Para los rectos C210.

B. Para los curvados C210.

C. Para los curvados C245.

D. Para los rectos C245.

*Importante

Es imprescindible insertar los cartuchos hasta la marca para una conexión correcta.

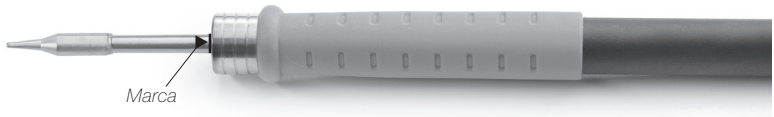

Cambio de cartuchos de los mangos T470

1. Retire

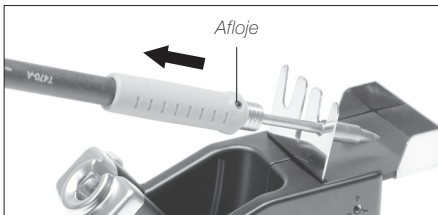

Afloje el tornillo y coloque el lápiz soldador en las ranuras del extractor para retirar el cartucho.

2. Inserte

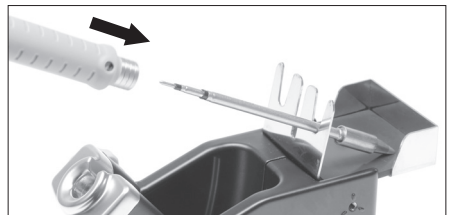

Coloque el lápiz soldador en el nuevo cartucho empujando ligeramente hasta la marca y apriete el tornillo.

Compatibilidad

| Mango Soldador | Gama de cartuchos | CD | Soporte | DI | DDE | DME | HDE |
|----------------|-------------------|----|---------|----|-----|-----|-----|
| T210-A | C210 | ● | AD-SD | ● | ● | ● | |
| T210-PA | | ● | | ● | ● | | |
| T245-A | C245 | ● | | ● | ● | | |
| T245-PA | | ● | | ● | ● | | |
| T245-B | | ● | | ● | ● | | |
| T245-C | | ● | | ● | ● | | |
| T470-A | C245 | ● | AD-SD | ● | ● | ● | |
| | C470 | | HD-SD | | | | ● |
| T470-B | C245 | ● | AD-SD | ● | ● | ● | |
| | C470 | | HD-SD | | | | ● |
| T470-SA | C245 | ● | AD-SD | ● | ● | ● | |
| | C470 | | HD-SD | | | | ● |
| T470-ZA | C245 | ● | AD-SD | ● | ● | ● | |
| | C470 | | HD-SD | | | | ● |
| T470-FA | C245 | ● | AD-SD | ● | ● | ● | |
| | C470 | | HD-SD | | | | ● |
| T470-MC | C245 | ● | AD-SD | ● | ● | ● | |
| | C470 | | HD-SD | | | | ● |
| T210-NA* | C210 | | DN-SE | ● | ● | ● | |
| T245-NA* | C245 | | | ● | ● | ● | |
| T470-NA* | C245 | | | ● | ● | ● | |
| | C470 | | | | | | |

*El regulador de caudal de nitrógeno MNE es necesario. Utilice la boquilla adecuada en función del cartucho.

Accesorios

Fume extractor

Aspirahumos

Ref. F3435 (Para T245 / T470)

Ref. F3450 (Para T210)

Las bridas se pueden quitar fácilmente para un mantenimiento rápido.



Cable collector

Recogecable

Ref. CC3702

Mantiene el área de trabajo libre de cables.

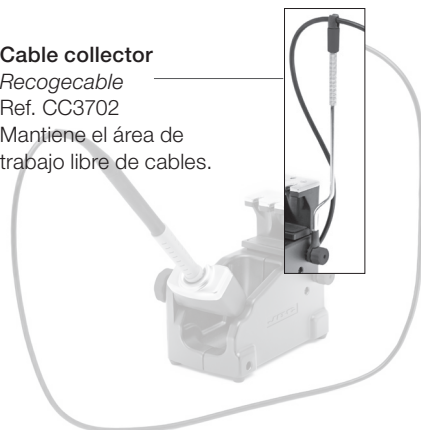

Seguridad



Es necesario cumplir estas normas de seguridad para prevenir cualquier choque eléctrico, heridas, fuego o explosiones.

- No utilice los mangos para otros fines que no sea la soldadura. El uso incorrecto puede causar fuego.
- Al desenchufarlo, tire del conector, no del cable.
- No trabaje con tensión.
- La herramienta debe permanecer en el soporte cuando no está en uso con el fin de activar el modo de Sleep. El cartucho, la parte metálica de la herramienta y el soporte puede estar caliente incluso cuando la estación está apagada. Manipule con cuidado, incluso cuando ajuste la posición del soporte.
- No deje el aparato desatendido cuando esté en funcionamiento.
- Evite el contacto del Flux con la piel o los ojos para prevenir la irritación.
- Tenga cuidado con el humo producido al trabajar.
- Mantenga su lugar de trabajo limpio y ordenado. Use gafas y guantes de protección adecuados. Así evitará cualquier daño.
- Tenga cuidado con los restos de estaño líquido. En contacto con la piel, puede causar quemaduras.
- Esta herramienta puede ser utilizada por personas a partir de 8 años y también por aquellas personas con movilidad reducida o capacidades físicas, sensoriales o mentales limitadas o con falta de experiencia y conocimientos siempre y cuando reciban supervisión o instrucciones relativas al uso del aparato de una manera segura y entiendan los riesgos que implica. Los niños no deben jugar con ello.
- Los niños no deberán realizar tareas de mantenimiento sin supervisión.

Mantenimiento

Antes de su mantenimiento, desconecte la herramienta.

- Compruebe periódicamente que las partes metálicas de la herramienta y el soporte estén limpias de modo que la estación pueda detectar el estado de la herramienta y activar así los modos Sleep o Hibernation.
- Revise la conexión de cables y/o tubos.
- Cambie cualquier pieza defectuosa o dañada. Utilice solamente recambios originales de JBC.
- Cualquier reparación sólo podrá ser realizado por un servicio técnico oficial JBC.

Handstücken

Ref. T210 / T245 / T470

Merkmale

Für C245-Kartuschensortiment

Diese Handstücke für allgemeine Anwendungen eignen sich perfekt sowohl für SMD-Komponenten als auch für Arbeiten mit hohen Leistungsanforderungen (z.B. Lötungen an Masseplatten).

General Purpose Handle

Universal-Handstück

Ref. T245-A



Blue Handle · Universal-Handstück, blauer Griff

Ref. T245-PA



Non-slip Handle · Universal-Handstück, rutschfester Griff

Ref. T245-B



Soft Thermal Insulator Handle · Schaumstoffgriff mit Wärmeisolierung

Ref. T245-C



Ersetzen Sie problemlos die T245 Griffe, und T210 Griffe (Ref. 0016057 und Ref. 0018658)

1. Streifen einschieben

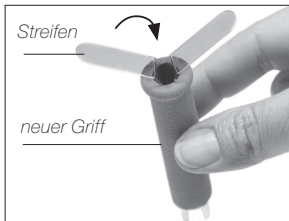

Stecken Sie die Gleitstreifen in den neuen Griff.

2. Handstück einführen

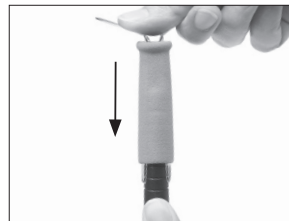

Schieben Sie den Griff mit den Streifen auf das Handstück.

3. Streifen herausziehen

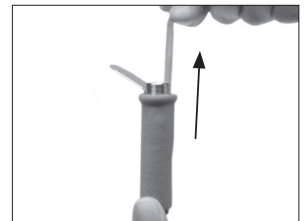

Um die Streifen zu entfernen, halten Sie den Griff fest und ziehen sie heraus.

Hinweis: Alle Modelle werden mit einem 1,5 m langen Kabel ausgeliefert

Für C210-Kartuschensortiment

Die T210 eignen sich perfekt für Präzisionsarbeiten mit mittleren Leistungsanforderungen. Aufgrund seiner Größe sind sie dazu in der Lage, bei mittleren und/oder kleinen Komponenten sogar unter einem Mikroskop zu arbeiten.

Precision Purpose Handle · Präzisions-Handstück

Ref. T210-A

**Blue Precision Handle · Präzisions-Handstück, blauer Griff**

Ref. T210-PA

**Für C245 und C470-Kartuschensortiment**

Für intensive Lötarbeiten, die ständig hohe Temperaturanforderungen stellen. Sie weisen einen rutschfesten Griff auf und verfügen über eine Schraube, welche die Kartusche fixiert und deren Rotation und Bewegung unterbindet.

HD Purpose Handle*HD Handstück*

Ref. T470-A

**Heavy Duty HD Handle***Hochleistungs HD Handstück*

Ref. T470-B

HD Purpose Handle + 3m cable*HD Handstück mit Kabel 3 m*

Ref. T470-SA

Tri-lobed HD Handle · Dreilappiges Handstück

Ref. T470-ZA

**Thermal Insulator HD Handle***Wärmeisoliertes HD Handstück*

Ref. T470-FA

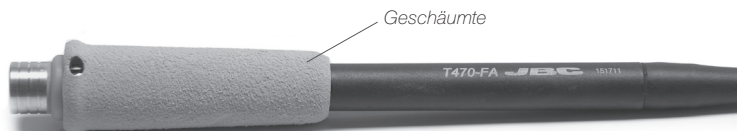
**Soft Thermal Insulator HD Handle + 3m cable***Schaumstoffgriff HD Handstück mit Kabel 3 m*

Ref. T470-MC

Hinweis:

Alle Modelle werden mit einem 1,5 m langen Kabel ausgeliefert außer diejenigen, bei denen 3 m spezifiziert ist.

Merkmale von Handstücken mit Stickstoffeintrag

Diese eignen sich zur Arbeit in sauerstofffreier Umgebung, wodurch eine bessere Lötqualität gewährleistet wird. Sie stellen zusätzliche Wärme an der Lötstelle bereit und tragen somit zur Rostvermeidung bei. An der Werkbank wird ein JBC- GN-A Stickstoff-Generator-Modul oder eine externe Stickstoffversorgung benötigt.

Für C210-Kartuschensortiment

Nitrogen Precision Handle · Handstück für Präzisionsanwendungen mit Stickstoff Eingangs
Ref. T210-NA



Düsen
Ref. B6647

Für C245-Kartuschensortiment

Nitrogen Handle
Handstück mit Stickstoff Eingangs
Ref. T245-NA



Düsen
Ref. B7243
B7244

Für C470-Kartuschensortiment

Nitrogen HD Handle
HD Handstück mit Stickstoff Eingangs
Ref. T470-NA



Düsen
Ref. B6193
B6194
B6195

Kartuschenwechsel

Vor dem Kartuschenwechsel

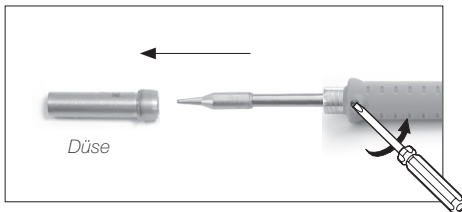

Zunächst die Düse abnehmen. Dann die Schraube lockern, um die Kartusche (T245-NA / T470-NA) herauszunehmen.

⚠ Benutzen Sie eine Zange, um noch heiße Düsen zu wechseln oder herauszunehmen.

Nach dem Kartuschenwechsel

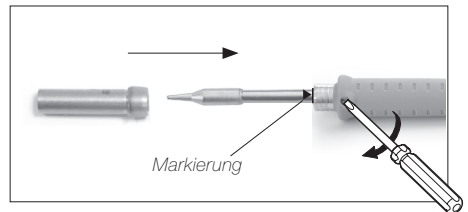

Stecken Sie die Kartusche ein, ziehen Sie die Schraube fest und setzen Sie dann die Düse auf.

T210 und T245-Kartuschenwechsel

Sparen Sie Zeit und wechseln Sie sicher Kartuschen, ohne die Station auszuschalten.

1. Entfernen

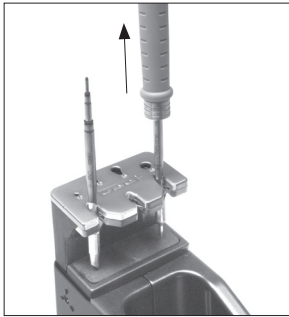

Handstück im Abzieher positionieren und Kartusche entfernen.

2. Einsetzen

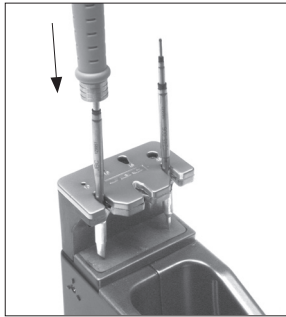

Handstück auf der neuen Kartusche positionieren, leichten Druck nach unten ausüben und Handstück aus dem Abzieher nehmen.

3. Fixieren

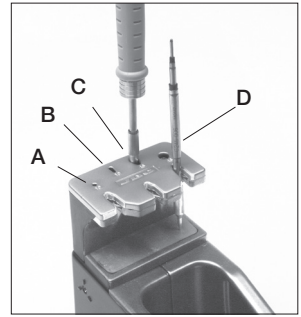

Drücken Sie die Kartusche* wie folgt in die Fixieröffnungen:

- A. Für gerade C210.
- B. Für abgeschrägte C210.
- C. Für abgeschrägte C245.
- D. Für gerade C245.

*Wichtig

Es ist wichtig, die Kartuschen für eine korrekte Verbindung genau bis zur Markierung einzustecken.

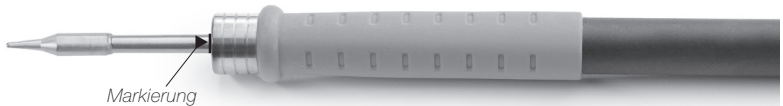

T470-Kartuschenwechsel

1. Entfernen

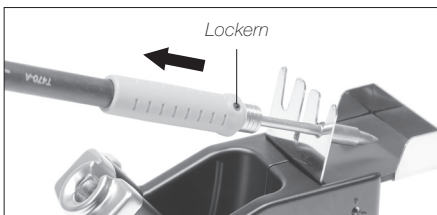

Lockern Sie die Schraube. Stecken Sie den Lötkolben in den Abzieher und entfernen Sie die Kartusche.

2. Einsetzen

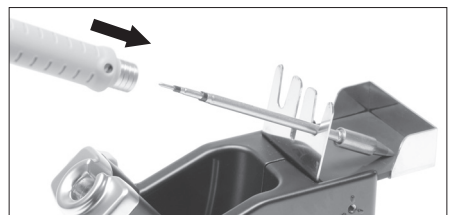

Setzen Sie die neue Kartusche ein und drücken Sie leicht bis zu der Markierung* und ziehen die Schraube fest.

Kompatibilität

| Handstück | Kartuschen-sortiment | CD | Ablage | DI | DDE | DME | HDE |
|-----------|----------------------|----|--------|----|-----|-----|-----|
| T210-A | C210 | ● | AD-SD | ● | ● | ● | |
| T210-PA | | ● | | ● | ● | ● | |
| T245-A | C245 | ● | | ● | ● | ● | |
| T245-PA | | ● | | ● | ● | ● | |
| T245-B | | ● | | ● | ● | ● | |
| T245-C | | ● | | ● | ● | ● | |
| T470-A | C245 | ● | AD-SD | ● | ● | ● | |
| | C470 | | HD-SD | | | | ● |
| T470-B | C245 | ● | AD-SD | ● | ● | ● | |
| | C470 | | HD-SD | | | | ● |
| T470-SA | C245 | ● | AD-SD | ● | ● | ● | |
| | C470 | | HD-SD | | | | ● |
| T470-ZA | C245 | ● | AD-SD | ● | ● | ● | |
| | C470 | | HD-SD | | | | ● |
| T470-FA | C245 | ● | AD-SD | ● | ● | ● | |
| | C470 | | HD-SD | | | | ● |
| T470-MC | C245 | ● | AD-SD | ● | ● | ● | |
| | C470 | | HD-SD | | | | ● |
| T210-NA* | C210 | | DN-SE | ● | ● | ● | |
| T245-NA* | C245 | | | ● | ● | ● | |
| T470-NA* | C245 | | | ● | ● | ● | |
| | C470 | | | | | | |

*Der MNE-Stickstoff-Fluss-Regulator wird benötigt. Benutzen Sie die für die jeweilige Kartusche geeignete Düse.

Zubehör

Fume extractor

Rauchabzug

Ref. F3435 (für T245 / T470)

Ref. F3450 (für T210)

Zur schnellen Wartung können Clips einfach entfernt werden.



Cable collector

Kabelausleger

Ref. CC3702

Hält den Arbeitsbereich frei von Kabel

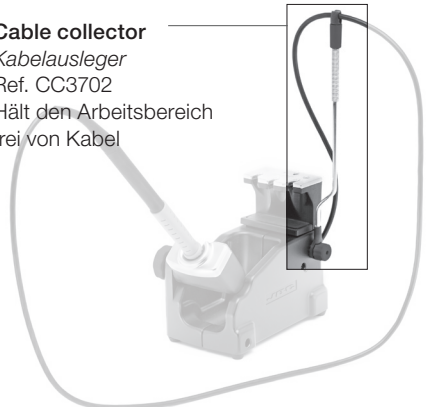

Sicherheit



Die Sicherheits-Leitlinien müssen unbedingt eingehalten werden, um elektrischen Schlag, Verletzung, Feuer oder Explosion zu vermeiden.

- Die Anlage für keinen anderen Zweck verwenden als zum Löten oder Entlöten. Unsachgemäße Verwendung kann Feuer hervorrufen.
- Das Netzkabel muss in zugelassene Steckdosen eingesteckt werden. Vergewissern Sie sich vor der Benutzung, dass sie korrekt geerdet ist. Beim Herausziehen, am Stecker ziehen, nicht am Kabel.
- Nicht an aktiven Bauteilen arbeiten.
- Das Werkzeug sollte bei Nichtgebrauch in der Ablage abgestellt werden, um die Betriebsart Sleep auszulösen. Die Lötspitze, der metallische Teil des Werkzeugs und die Ablage können noch heiß sein, wenn die Station ausgeschaltet ist. Gehen Sie vorsichtig vor, sogar wenn Sie die Standposition justieren.
- Das eingeschaltete Gerät niemals unbeaufsichtigt lassen.
- Ein als "ohne Rückstände" eingestuftes Flussmittel verwenden und die Berührung mit Haut oder Augen vermeiden, um Reizung zu vermeiden.
- Sich vor dem beim Löten entstehenden Rauch in Acht nehmen.
- Ihren Arbeitsplatz sauber und aufgeräumt halten. Bei der Arbeit geeignete Schutzbrille und Handschuhe tragen, um gesundheitliche Schäden zu vermeiden.
- Im Umgang mit flüssigen Zinnrückständen muss äußerste Sorgfalt walten.
- Dieses Gerät kann von Kindern über acht Jahren und auch Personen mit körperlicher, sinnlicher oder geistiger Behinderung oder mangelnder Erfahrung benutzt werden, nachdem ihnen angemessene Überwachung oder Einweisung hinsichtlich der Verwendung des Geräts und der damit verbundenen Risiken gegeben worden ist. Kinder dürfen mit dem Gerät nicht spielen.
- Wartung darf nicht von Kindern durchgeführt werden, wenn sie hierbei nicht beaufsichtigt werden.

Wartung

- Vor Durchführung von Wartungsarbeiten am Werkzeug, das Werkzeug vom Stromnetz trennen.
- Benutzen Sie einen feuchten Lappen, um das Gehäuse und das Werkzeug zu reinigen. Alkohol darf nur zur Reinigung der Metallteile benutzt werden.
 - Überprüfen Sie regelmäßig alle Kabel und Schlauchanschlüsse.
 - Jedes defekte oder schadhafte Teil austauschen. Nur Original-Ersatzteile von JBC verwenden.
 - Reparaturen dürfen nur von dem Vertragskundendienst von JBC durchgeführt werden.

焊铁手柄

Ref. T210 / T245 / T470

产品特性

用于 C245 烙铁头系列

这一通用型焊笔非常适用于 SMD 组件以及对功率要求较高的作业 (例如, 接地面焊接)。

普通用途手柄 Ref. T245-A



蓝色普通用途手柄 Ref. T245-PA

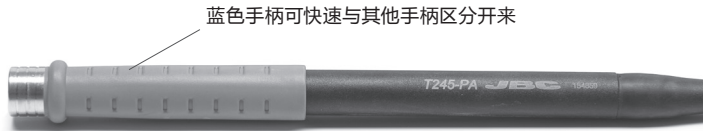

防滑手柄 Ref. T245-B



柔软握柄隔热型 Ref. T245-C



使用滑动标签可轻松更换T245 / T210 握套 (Ref. 0016057 & Ref. 0018658) 。

1. 插入标签

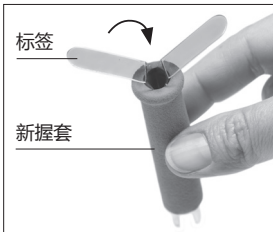

将滑动标签插入新握套内。

2. 套上手柄

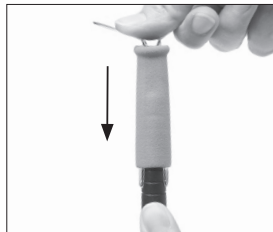

顺着标签将握套套上手柄。

3. 移去标签

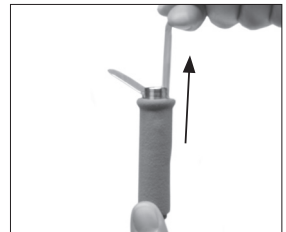

要移去标签, 握住手柄并向外拉。

注意: 所有型号都配有1.5米电线。

用于 C210 烙铁头系列

T210 非常适用于功率要求适中的精密焊接作业。

其尺寸优势使其能够与传统型或小型 SMD 配合使用,即使是在显微镜下亦如此。

精确用途手柄

Ref. T210-A



蓝色精确手柄

Ref. T210-PA



用于 C245 及 C470 烙铁头系列

用于要求持续热功率的高强度焊接作业。配备有一个热绝缘效果极佳的防滑握柄,以及一个用于固定烙铁头并防止其打滑的螺钉。

普通用途HD手柄

Ref. T470-A

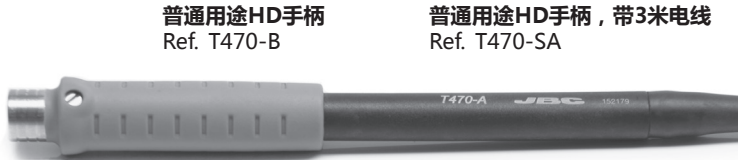

普通用途HD手柄

Ref. T470-B

普通用途HD手柄,带3米电线

Ref. T470-SA

三叶型手柄

Ref. T470-ZA

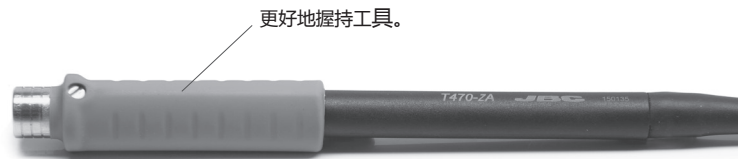

隔热HD手柄

Ref. T470-FA

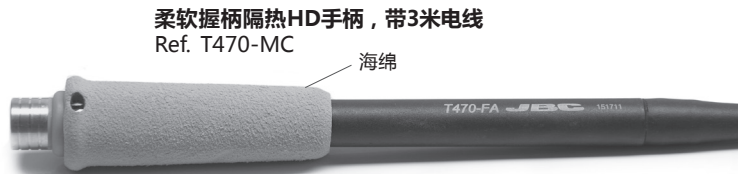

注意:所有型号都配有1.5米电线,配有3米电线的型号除外。

氮气手柄功能

这些都是用于在无氧的情况下,提供更好质量的焊接工作。这些产品提供额外的热量到焊点,并有助于防止氧化。具体操作时需要使用JBC GN-A氮气发生器模块或外接氮气供给。

用于 C210 烙铁头系列

精细用途氮气手柄

Ref. T210-NA



喷嘴
Ref. B6647

用于 C245 烙铁头系列

普通用途氮气手柄

Ref. T245-NA

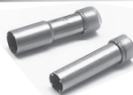

喷嘴
Ref. B7243
B7244

用于 C470 烙铁头系列

HD 氮气手柄

Ref. T470-NA



喷嘴
Ref. B6193
B6194
B6195

烙铁头更换

更换烙铁头以前

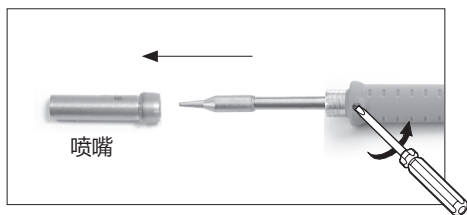

首先取下喷嘴,然后拧松螺丝,取下烙铁头(T245-NA / T470-NA)。⚠注意,高温时使用用钳子更换或取下喷嘴。

更换烙铁头以后

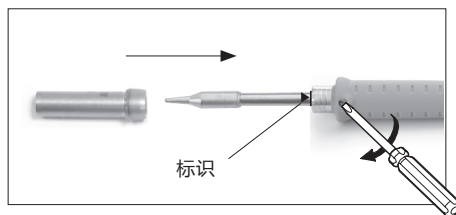

插入烙铁头,拧紧螺丝,然后安装喷嘴。

T210&T245烙铁头更换

节省时间,安全更换烙铁头,主机无需断电。

1. 移除

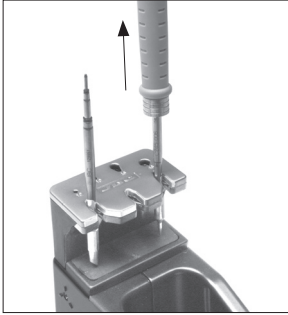

将手柄放置在插拔座上,拔出烙铁头。

2. 插入

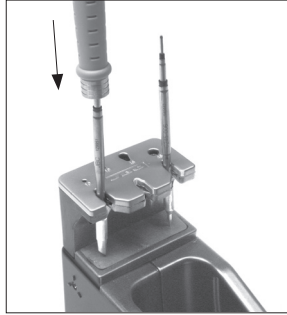

将手柄置在新烙铁头顶端,轻轻下压。

3. 固定

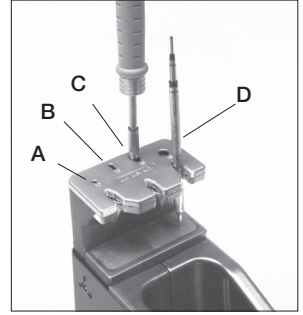

使用孔洞来固定烙铁头*,操作如下:

- A. 直线型烙铁头 C210.
- B. 弯曲型烙铁头 C210.
- C. 弯曲型烙铁头 C245.
- D. 直线型烙铁头 C245.

*重要

切记尽量将烙铁头插入到标识处,以确保正确的连接。

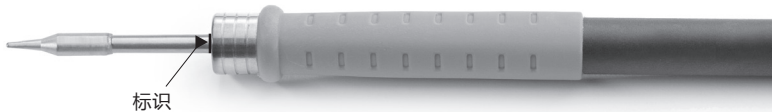

T470烙铁头更换

1. 移除

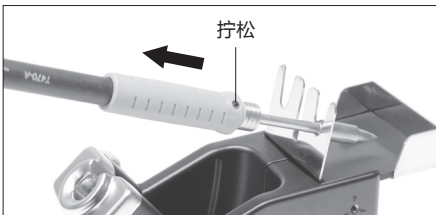

拧松螺丝,把焊接笔插入卸笔工具,然后卸除烙铁头。

2. 插入

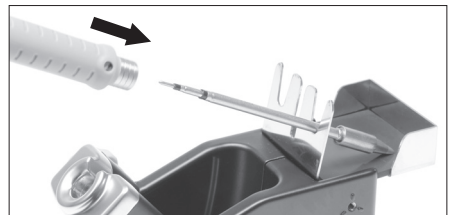

插入新烙铁头,并轻轻插到标识处再拧紧。

兼容性

| 焊铁手柄 | 烙铁头系列 | CD | Stand | DI | DDE | DME | HDE |
|----------|-------|----|-------|----|-----|-----|-----|
| T210-A | C210 | ● | AD-SD | ● | ● | ● | |
| T210-PA | | ● | | ● | ● | ● | |
| T245-A | C245 | ● | | ● | ● | ● | |
| T245-PA | | ● | | ● | ● | ● | |
| T245-B | | ● | | ● | ● | ● | |
| T245-C | | ● | | ● | ● | ● | |
| T470-A | C245 | ● | AD-SD | ● | ● | ● | |
| | C470 | | HD-SD | | | | ● |
| T470-B | C245 | ● | AD-SD | ● | ● | ● | |
| | C470 | | HD-SD | | | | ● |
| T470-SA | C245 | ● | AD-SD | ● | ● | ● | |
| | C470 | | HD-SD | | | | ● |
| T470-ZA | C245 | ● | AD-SD | ● | ● | ● | |
| | C470 | | HD-SD | | | | ● |
| T470-FA | C245 | ● | AD-SD | ● | ● | ● | |
| | C470 | | HD-SD | | | | ● |
| T470-MC | C245 | ● | AD-SD | ● | ● | ● | |
| | C470 | | HD-SD | | | | ● |
| T210-NA* | C210 | | DN-SE | ● | ● | ● | |
| T245-NA* | C245 | | | ● | ● | ● | |
| T470-NA* | C245 | | | ● | ● | ● | |
| | C470 | | | | | | |

*MNE氮气流量调节器是必需的，根据烙铁头使用适当的喷嘴。

配件

除烟机

Ref. F3435 (为T245 / T470)

Ref. F3450 (为T210)

可以轻易取出夹子
以便快速操作。



集线器

Ref. CC3702

保持工作区域无
电线干扰

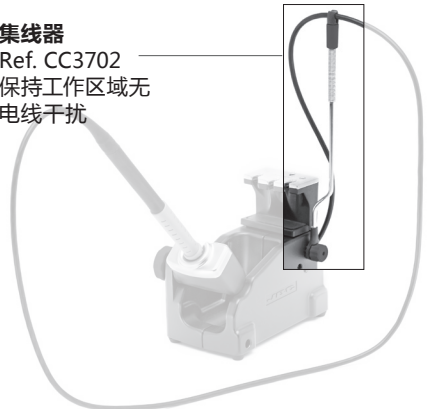

安全



必须遵守安全准则，以防止电击，人身伤害，火灾或爆炸。

- 不要使用本产品用于焊接或返修以外的任何目的。不正确使用可能造成火灾。
- 电源线必须插入核准的电源。确保使用前妥善接地。拔掉电源时握住插头，而不是电线。
- 请勿在带电部件上操作。
- 该工具在不使用时应放置在支架上，以激活休眠模式。
烙铁头，金属部分和支架即使在焊台被切断电源时仍旧是热的。
小心轻放，包括调整支架位置时。
- 设备开着时，切勿无人看管。
- 请勿覆盖通风口。热量可引起易燃物品引燃。
- 使用“无残渣”类锡丝，避免与皮肤或眼睛接触，以防刺激。
- 小心焊接时产生的烟雾。
- 保持工作场所干净整洁。操作时，为避免造成人身伤害，请穿戴适当的防护眼镜和手套。
- 残锡液易引起灼伤，请小心处理。
- 本产品允许八岁以上儿童，肢体，感官或心智有残缺的人士，以及缺乏经验的人士使用，
但必须提供必要的监护及指导，并且了解本产品可能涉及的危险。切勿让儿童把玩。
- 没有监管，儿童不得对本产品进行维护。

维护

之前进行维修，请务必拔下支架和工具。

- 定期检查工具金属件及支架，确保清洁，确保主机可以保持探测到工具状态。
- 定期检查电线和管子。
- 更换任何受损的元件。仅使用JBC原装配件。
- 修理必须由JBC专业技术服务人员进行。

Warranty

JBC's 2 year warranty covers this equipment against all manufacturing defects, including the replacement of defective parts and labour.

Warranty does not cover product wear or misuse.

In order for the warranty to be valid, equipment must be returned, postage paid, to the dealer where it was purchased.

Garantía

Esta garantía de 2 años cubre este equipo contra cualquier defecto de fabricación, incluyendo la sustitución de partes defectuosas y mano de obra.

La garantía no cubre el desgaste del producto por uso o mal uso.

Para que esta garantía sea válida, el equipo debe ser devuelto, a portes pagados, al distribuidor donde se compró.

Garantie

Die 2-Jahres-Garantie von JBC erstreckt sich auf das Gerät bei Herstellungsfehlern, einschließlich Fehlern der Verarbeitung und dem Ersatz defekter Teile und deren Austausch.

Die Garantie gilt nicht für Produktverschleiß durch normale Nutzung oder durch falsche Anwendung.

Damit die Garantie Gültigkeit erlangt, muß das Gerät an den Händler, bei dem es gekauft wurde, zurückgesandt werden (Porto bezahlt).

保修

JBC的2年保修涵盖了该设备所有的制造缺陷，包括更换有缺陷的零件和人工耗时。

保修不包括因过度使用或误用而产生的产品损坏。

为了使保修有效，设备须返还至购买时的经销商处返修，邮资自理。



This product should not be thrown in the garbage.

In accordance with the European directive 2012/19/EU, electronic equipment at the end of their life must be collected and returned to an authorized recycling facility.

Este producto no debe desecharse en la basura.

De acuerdo a la directiva europea 2012/19/UE, los equipos electrónicos al final de su vida se deberán recoger y trasladar a una planta de reciclaje autorizada.

Dieses Produkt sollte nicht mit dem Hausmüll entsorgt werden.

In Übereinstimmung mit der europäischen Richtlinie 2012/19/EU müssen elektronische Geräte am Ende ihrer Lebensdauer eingesammelt und einem autorisierten Recyclingbetrieb zugeführt werden.

本产品不应被扔在垃圾筒内。

根据欧盟条款2012/19/EU，电子设备在其寿命结束后必须被回收并转运至授权回收工厂。