

JBC

www.jbctools.com

English



Premium Desoldering station with Electric Pump

Ref. DIS-D

Packing List

The following items should be included:

DI Control Unit 1 unit
Ref. DI-1D (120V)
DI-2D (230V)
DI-9D (100V)



Electric Desoldering Module..... 1 unit
Ref. MS-A



Stand 1 unit
Ref. DR-SD



Desoldering Iron..... 1 unit
Ref. DR560-A



Tip Cleaning Stand 1 unit
Ref. CL9885



Sponge 1 unit
Ref. S0354



Metal Brush 1 unit
Ref. CL6217



Stand Cable 1 unit
Ref. 0011283



Power cord 1 unit
Ref. 0009417 (100V/120V)
0009401 (230V)



Module Cable 1 unit
Ref. 0010207



DR560 Accessories..... 1 unit



Tip 1 unit
Ref. C560013



Tip 1 unit
Ref. C560004



Tip 1 unit
Ref. C560005



Manual 1 unit



Long Cleaning tips set
Ref. 0965760



Cleaning tips set
Ref. 0965970



Internal joint Case
Ref. 0812360 (x2)



Filter Box 1 unit
Ref. 0780840
It contains 10 filters



Metal tin deposit 1 unit
Ref. 0812630



Cotton Filter 10 unit
Ref. 0781046



Tin deposit 1 unit
Ref. 0812620



Filter Box 1 unit
Ref. 0005966
It contains 50 filters



Cleaning stick 1 unit
Ref. 0786640



Suction Filter 1 unit
Ref. 0821830



Spanner 1 unit
Ref. 0780550



Features

DI Control Unit
Ref. DI-1D (120V)
DI-2D (230V)
DI-9D (100V)

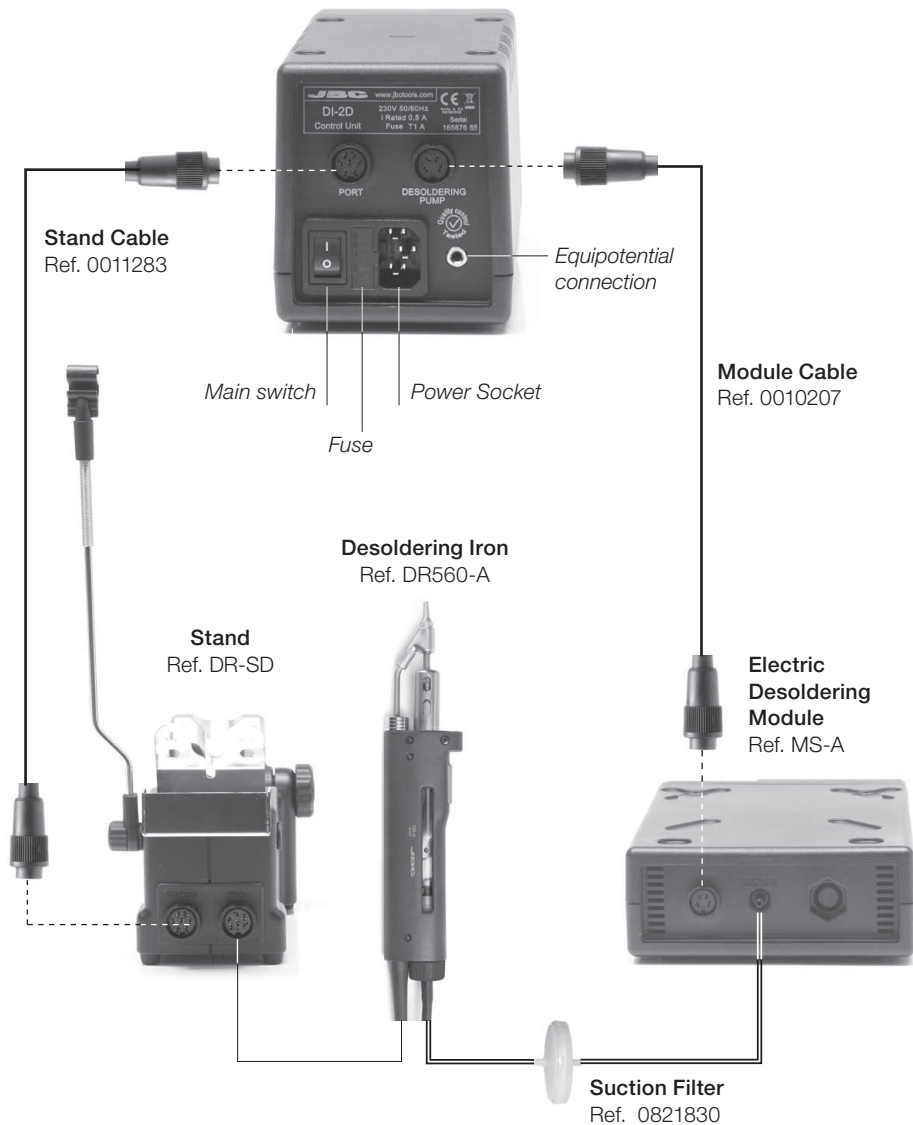

USB Connector

Download the latest software from our website to improve your soldering station.

JBC Updater

www.jbctools.com/software.html

Update the station software via USB connection:

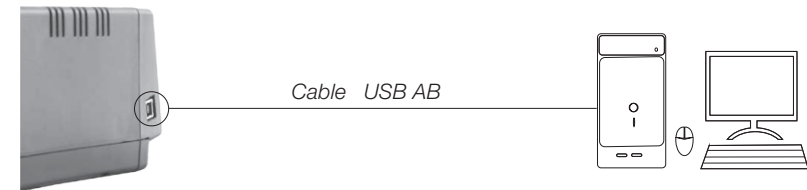

JBC Manager

www.jbctools.com/manager.html

Manage and monitor as many stations as your Windows PC can handle by using the JBC Manager. You can export data to another PCs.

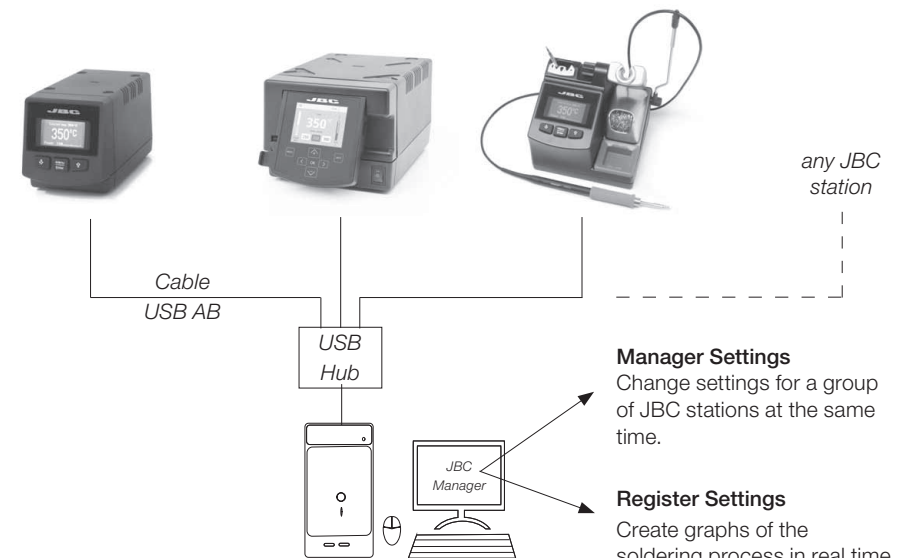

Manager Settings

Change settings for a group of JBC stations at the same time.

Register Settings

Create graphs of the soldering process in real time with power and temperature data.

Stand

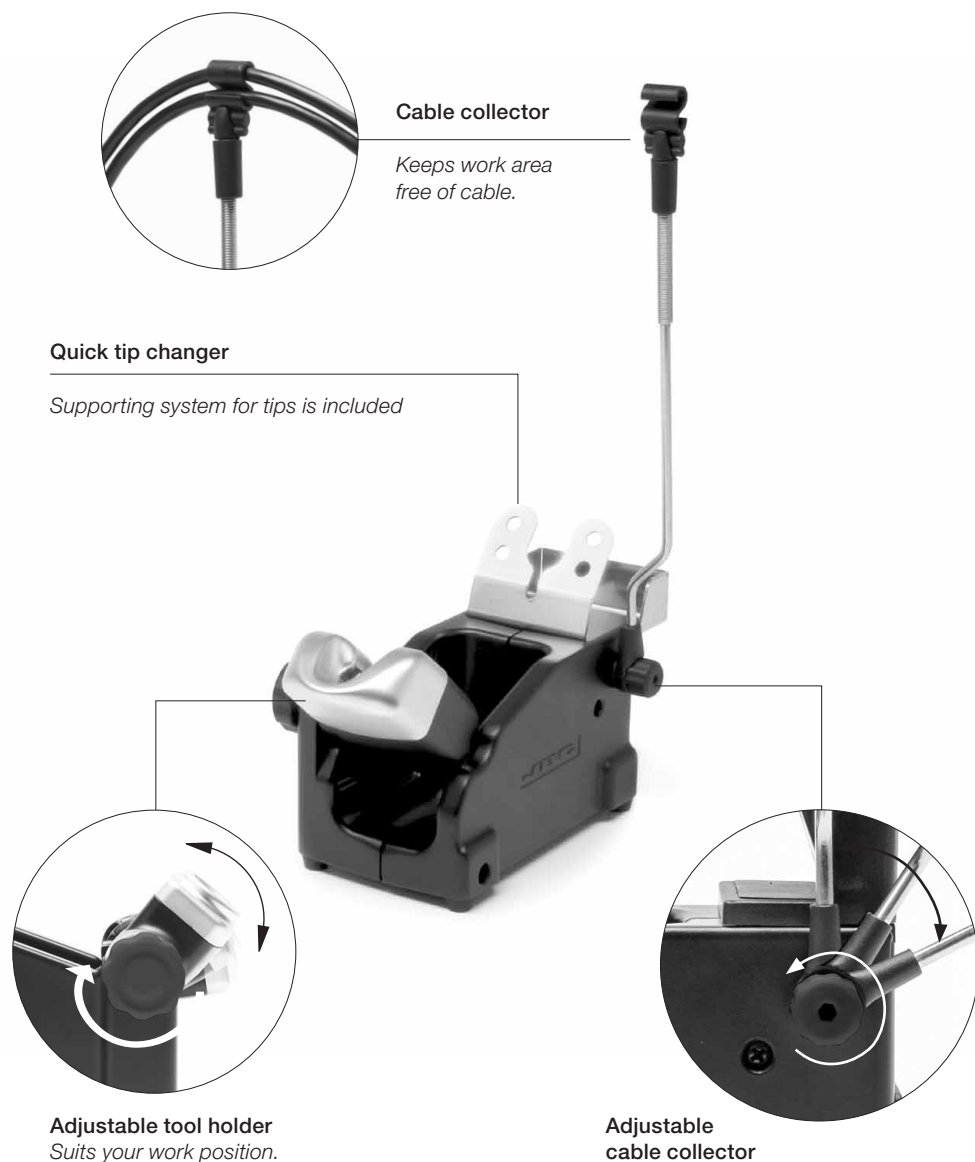

Tip Cleaner

Improve thermal transfer by cleaning the tip after each solder joint.

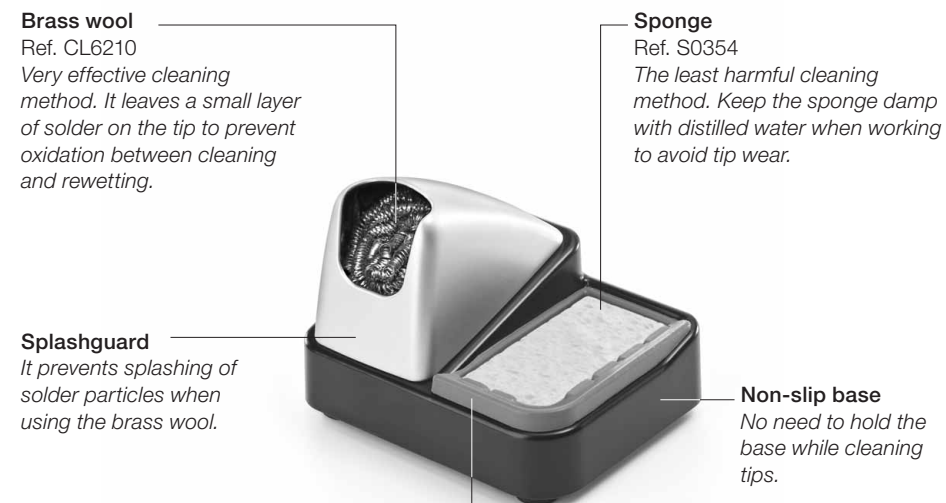

Wiper
Ref. CL0236
A temperature resistant receptacle lets the operator remove excess solder by gentle tapping or wiping. It can be easily removed for cleaning.

Tapping:

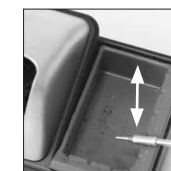

Tap gently to remove excess solder.

Wiping:

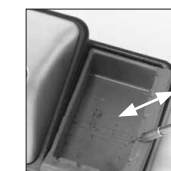

Use the slots to remove remaining particles.

Optional

Inox wool
Ref. CL6205



Brushes
Ref. CL6220



Tip-tinner
Ref. TT-A



Sand
Ref. CL6211



Operation

The JBC Exclusive Heating System

This revolutionary technology is able to recover the tip temperature extremely quickly. This allows the user to work at a lower temperature. As a result, tip life is extended by 5.

1. Work



When the tool is lifted from the stand it will heat up to the selected temperature.

2. Sleep



When the tool is in the stand, the temperature falls to 180°C / 360°F (preset sleep temperature).

3. Hibernation

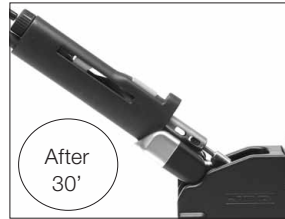

After longer periods of inactivity (pre-set to 30 min.), the power is cut off and the tool cools down to room temperature.

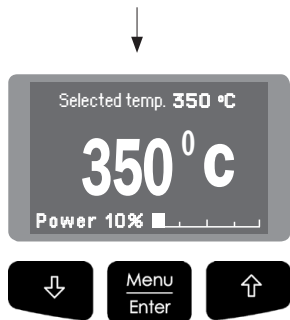

- Change temperature (from 90 to 450°C)
- Set temperature limits
- Select temperature levels
- Fix one temperature

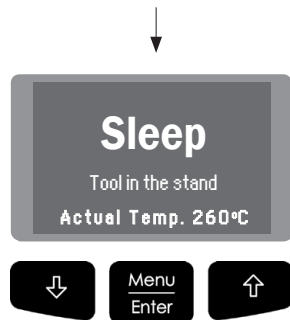

- Change Sleep temperature
- Set Sleep delay (from 0 to 9 min or no Sleep)

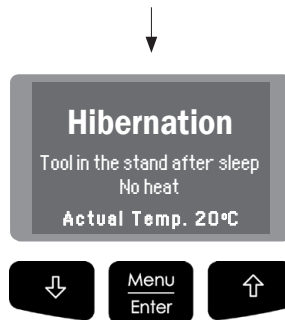

- Set Hibernation delay (from 0 to 60 min or no hibernation)

Process Control

Work Screen

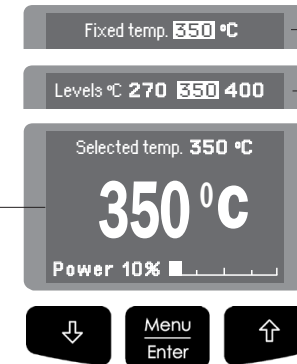

Displays a specific fixed temp.

Shown when you have selected temp. levels.

The work screen provides useful information of tool status in real time.

Menu Screen

Original PIN: 0105

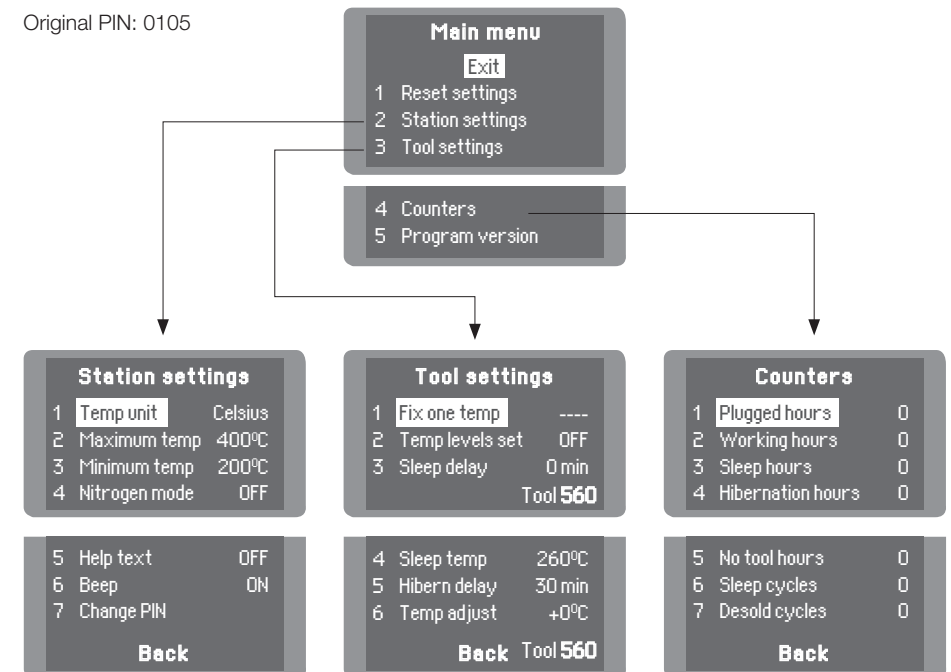

Desoldering process

Use a tip with a larger diameter than the pad to achieve maximum aspiration and thermal efficiency.

1. Placing

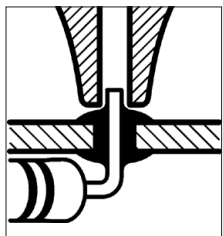

Place the tip with the component terminal in the hole.

2. Rotating

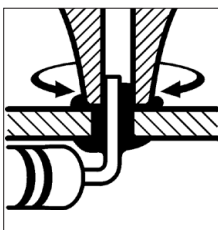

When the solder liquefies, gently rotate the tip so that the component terminal can be lifted off.

3. Aspirating

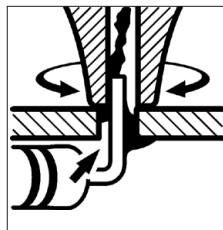

Press the vacuum pump button long enough to remove the solder.

After pressing the desoldering key there is a slight delay until the self-contained vacuum pump stops. This makes sure that the vacuum circuit is completely empty. If any solder remains are left on a terminal after desoldering it, resolder it with fresh solder and repeat the desoldering operation.

Changing Tips

This operation should be done while the tip is hot, not below 250°C, so that any tin left inside is in molten state.

1. Removing

Unscrew the tip using the spanner supplied.

2. Inserting

Fit the new tip and tighten with the spanner to make sure it is air tight.



Compatible Tips

The DR560 works with C560 tips. Find the model that best suits your work needs in www.jbctools.com

Changing the Heating Element

To perform this operation, turn off the station or disconnect the tool.

1. Loosening

The deposit lid needs to be loosened.

2. Removing

Loosen the screw as shown and remove the Heating Element.



3. Placing

Place the new Heating Element and follow the steps conversely.



Important

For a proper connection it is essential to insert the cartridge by lining it up to the mark ▶.



Tin Deposit Cleaning

1. Removing the lid



The lid must be removed with the DR560 in vertical position.

3. Inserting the deposit

The deposit must be inserted with coil filter in place, positioned between the 2 lines marked on the tin deposit.

Then the whole unit must be closed by screwing the lid.

2. Cleaning

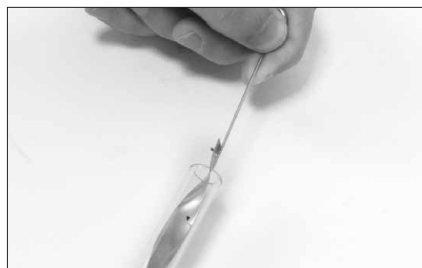

Remove the coil to clean the inside of the deposit with the stick supplied.



The filter and internal joint must be checked and replaced if dirty or damaged.

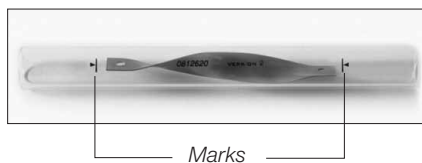

Tip Care

The intake tube should be periodically cleaned by the largest rod.

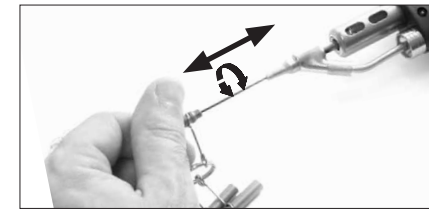
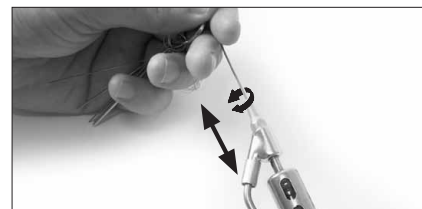

Important

DO NOT press the vacuum pump button while tinning the desoldering tip, as the fumes given off by the flux would quickly block the ducts and the air filter.

Changing the Pump Filters

Important

Do not use sharp pointed objects to open the suction filter.

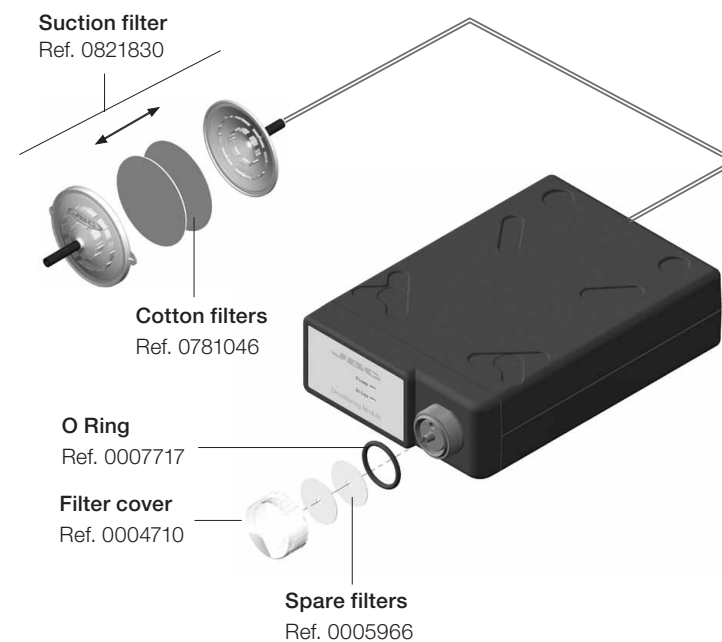

Maintenance

Before carrying out maintenance or storage, always allow the equipment to cool.

- Clean the station screen with a glass cleaner or a damp cloth.
- Use a damp cloth to clean the casing and the tool. Alcohol can only be used to clean the metal parts.
- Periodically check that the metal parts of the tool and stand are clean so that the station can detect the tool status.
- Maintain tip surface clean and tinned prior to storage in order to avoid tip oxidation. Rusty and dirty surfaces reduce heat transfer to the solder joint.
- Periodically check all cables and tubes.
- Replace a blown fuse as follows:

Clean periodically

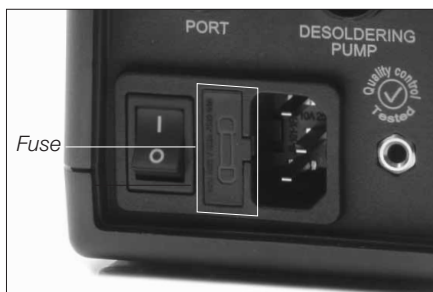

1. Pull off the fuse holder and remove the fuse. If necessary use a tool to lever it off.

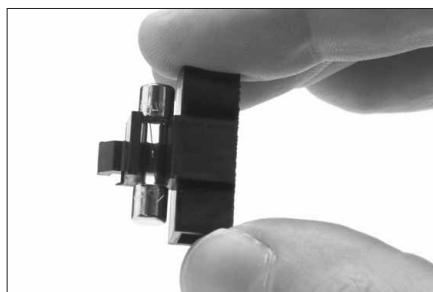

2. Press the new fuse into the fuse holder and replace it in the station.

- Replace any defective or damaged pieces. Use original JBC spare parts only.
- Repairs should only be performed by a JBC authorized technical service.

Safety



It is imperative to follow safety guidelines to prevent electric shock, injury, fire or explosion.

- Do not use the units for any purpose other than soldering or rework. Incorrect use may cause fire.
- The power cord must be plugged into approved bases. Be sure that it is properly grounded before use. When unplugging it, hold the plug, not the wire.
- Do not work on electrically live parts.
- The tool should be placed in the stand when not in use in order to activate the sleep mode. The soldering tip, the metal part of the tool and the stand may still be hot even when the station is turned off. Handle with care, including when adjusting the stand position.
- Do not leave the appliance unattended when it is on.
- It is necessary to turn the station off before changing tips.
- Do not cover the ventilation grills. Heat can cause inflammable products to ignite.
- Use a "non residue" classified flux and avoid contact with skin or eyes to prevent irritation.
- Be careful with the fumes produced when soldering.
- Keep your workplace clean and tidy. Wear appropriate protective glasses and gloves when working to avoid personal harm.
- Utmost care must be taken with liquid tin waste which can cause burns.
- This appliance can be used by children over the age of eight and also persons with reduced physical, sensory or mental capabilities or lack of experience provided that they have been given adequate supervision or instruction concerning use of the appliance and understand the hazards involved. Children must not play with the appliance.
- Maintenance must not be carried out by children unless supervised.

Exploded View

DIS-1D 120V
DIS-2D 230V
DIS-9D 100V
PREMIUM DESOLDERING STATION
WITH ELECTRIC PUMP

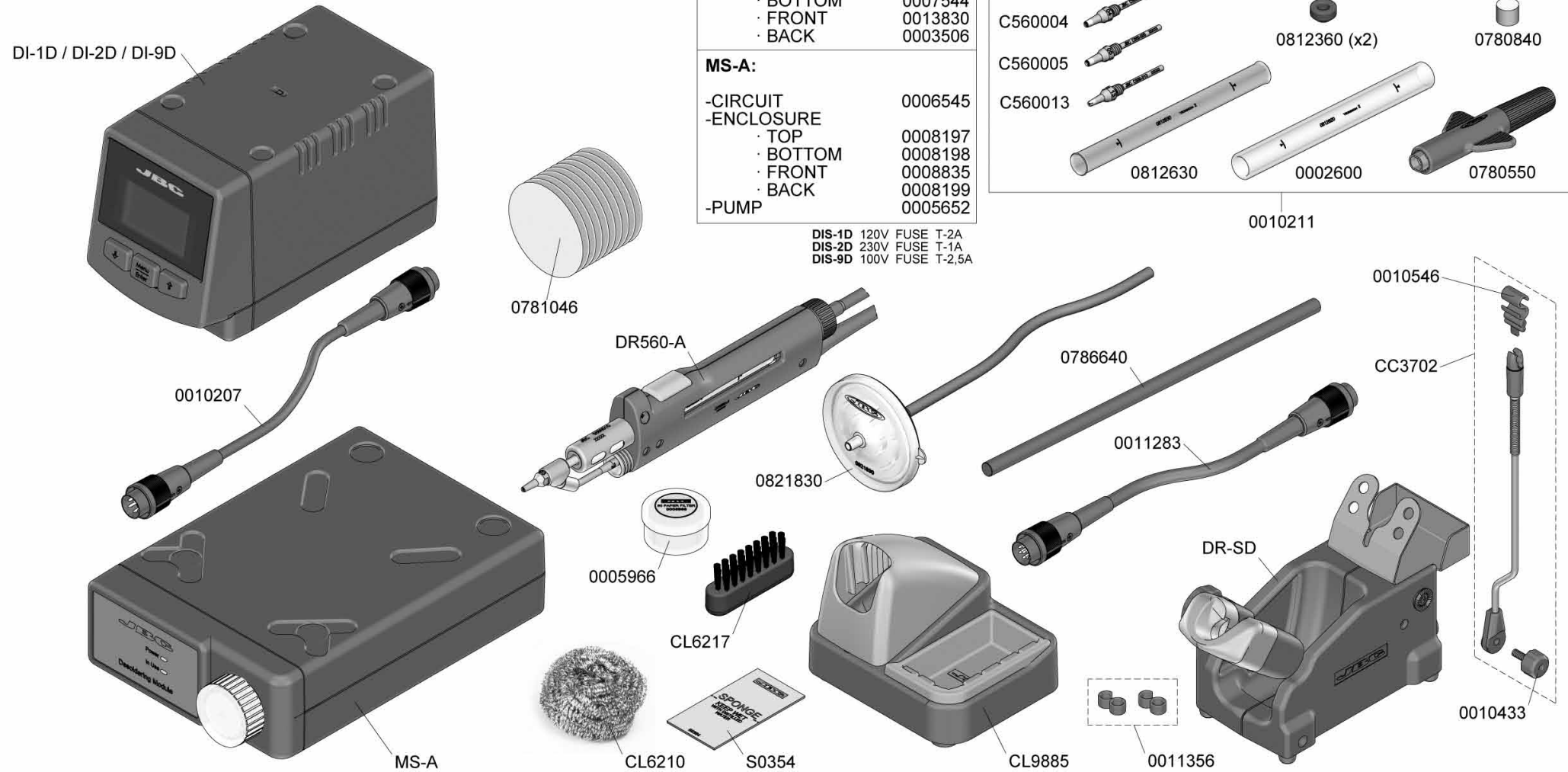

Specifications

Premium Desoldering station with Electric Pump

DIS-1D / DIS-2D / DIS-9D

- Total weight: 6.1 kg (13.4 lb)

DI-1D 120V 50/60Hz. Input fuse: 2A. Output: 23.5V.

DI-2D 230V 50/60Hz. Input fuse: 1A. Output: 23.5V.

DI-9D 100V 50/60Hz. Input fuse: 2.5A. Output: 23.5V.

- Total unit weight: 4.4 kg (9.6 lb)
- Size: 90 x 105 x 180 mm
- Temperature selection from 90°C (190°F) to 450°C (840°F)
- Output Peak Power: 130W
- Tip to ground resistance: <2 ohms
- Ambient operating temp: 10-40 °C / 50-104 °F
- USB connector station-PC

MS-A

- Total weight and size: 1.2 Kg (2.6lb) 145 x 55 x 225 mm
- Vacuum: 75% / 570 mmHg / 22.4 inHg
- Flow rate: 9 SLPM

Complies with CE standards

ESD protected housing "skin effect"

JBC

Warranty

JBC's 2 year warranty covers this equipment against all manufacturing defects, including the replacement of defective parts and labour.

Warranty does not cover product wear due to use or mis-use.

In order for the warranty to be valid, equipment must be returned, postage paid, to the dealer where it was purchased.



This product should not be thrown in the garbage.

In accordance with the European directive 2002/96/EC, electronic equipment at the end of their life must be collected and returned to an authorized recycling facility.